

MOS FIELD-EFFECT TRANSISTOR 2SJ178

P-CHANNEL MOS FET FOR HIGH-SPEED SWITCHING

OUTLINE DIMENSIONS (Unit : mm)

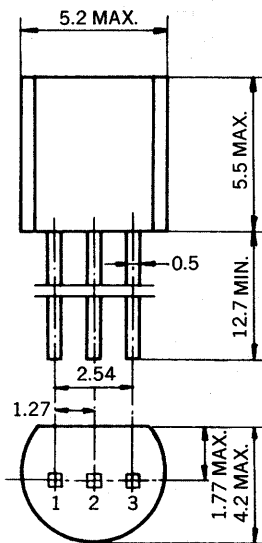

1. Gate (G)
2. Drain (D)
3. Source (S)

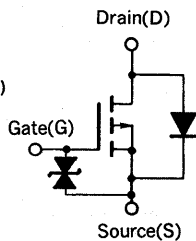

(Diode in the above figure is a parasitic diode.)

The 2SJ178 is a p-channel vertical type MOS FET switching device which can be directly driven from an IC operating with a 5 V single power supply. The device featuring low ON-state resistance is of the voltage drive type and thus is ideal for driving actuators such as motors, solenoids, and relays.

FEATURES

- Low ON-state resistance
 $R_{DS(on)} = 1.5 \Omega$ MAX. at $V_{GS} = -4$ V, $I_D = -0.5$ A
 $R_{DS(on)} = 1.0 \Omega$ MAX. at $V_{GS} = -10$ V, $I_D = -0.5$ A
- Voltage drive at logic level ($V_{GS} = -4$ V) is possible.
- Bidirectional zener diode for protection is incorporated in between the gate and the source.
- Inductive loads can be driven without protective circuit thanks to the improved breakdown voltage between the drain and source.

QUALITY GRADE

Standard

Please refer to "Quality grade on NEC Semiconductor Devices" (Document number IEI-1209) published by NEC Corporation to know the specification of quality grade on the devices and its recommended applications.

ABSOLUTE MAXIMUM RATINGS ($T_a = 25^\circ\text{C}$)

ITEM	SYMBOL	RATING	UNIT	TEST CONDITIONS
Drain to Source Voltage	V_{DSS}	-30	V	$V_{GS} = 0$
Gate to Source Voltage	V_{GSS}	± 20	V	$V_{DS} = 0$
Drain Current (DC)	$I_D(\text{DC})$	± 1.0	A	
Drain Current (pulse)	$I_D(\text{pulse})$	± 2.0	A	$PW \leq 10$ ms, Duty Cycle ≤ 50 %
Total Power Dissipation	P_T	750	mW	$T_a = 25^\circ\text{C}$
Channel Temperature	T_{ch}	150	$^\circ\text{C}$	
Storage Temperature	T_{stg}	-55 to +150	$^\circ\text{C}$	

ELECTRICAL CHARACTERISTICS ($T_a = 25^\circ\text{C}$)

ITEM	SYMBOL	MIN.	TYP.	MAX.	UNIT	TEST CONDITIONS
Drain Breaking Current	I_{DSS}			-10	μA	$V_{DS} = -30\text{ V}, V_{GS} = 0$
Gate Leakage Current	I_{GSS}			± 10	μA	$V_{GS} = \pm 20\text{ V}, V_{DS} = 0$
Gate Cutoff Voltage	$V_{GS(off)}$	-1.0	-2.2	-3.0	V	$V_{DS} = -10\text{ V}, I_D = -1\text{ mA}$
Forward Transfer Admittance	$ y_{fs} $	0.4			S	$V_{DS} = -10\text{ V}, I_D = -0.5\text{ A}$
Drain to Source ON-State Resistance 1	$R_{DS(on)1}$		0.8	1.5	Ω	$V_{GS} = -4\text{ V}, I_D = -0.5\text{ A}$
Drain to Source ON-State Resistance 2	$R_{DS(on)2}$		0.4	1.0	Ω	$V_{GS} = -10\text{ V}, I_D = -0.5\text{ A}$
Input Capacitance	C_{iss}		210		pF	$V_{DS} = -10\text{ V}, V_{GS} = 0, f = 1\text{ MHz}$
Output Capacitance	C_{oss}		130		pF	
Feedback Capacitance	C_{rss}		3		pF	
ON-State Delay Time	$t_{d(on)}$		35		ns	$I_D = -0.5\text{ A}, R_L = 50\ \Omega$ $V_{GS(on)} = -10\text{ V}$ $R_G = 10\ \Omega, V_{DD} = -25\text{ V}$
Rise Time	t_r		70		ns	
OFF-State Delay Time	$t_{d(off)}$		380		ns	
Fall Time	t_f		200		ns	

CHARACTERISTIC CURVES ($T_a = 25^\circ\text{C}$)

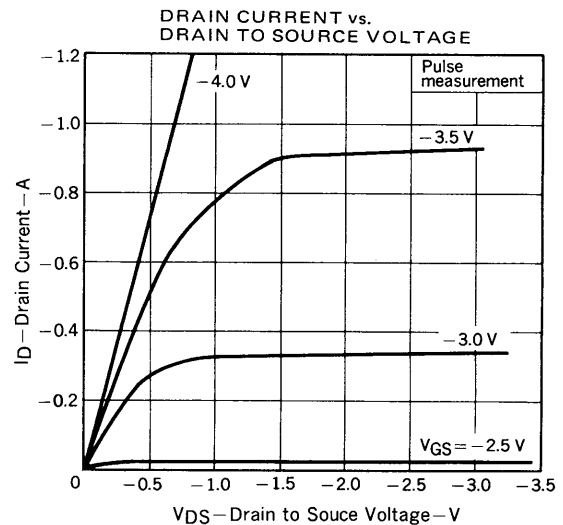
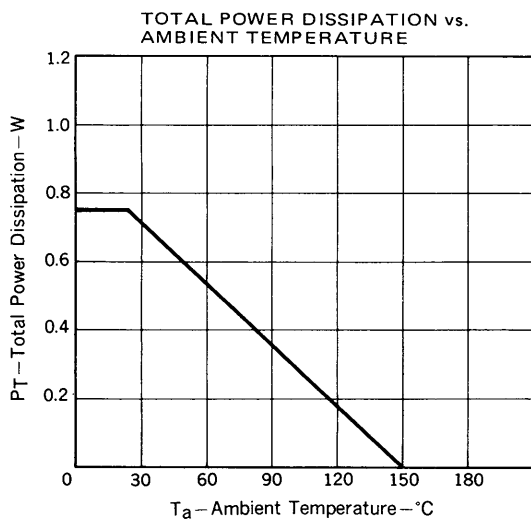
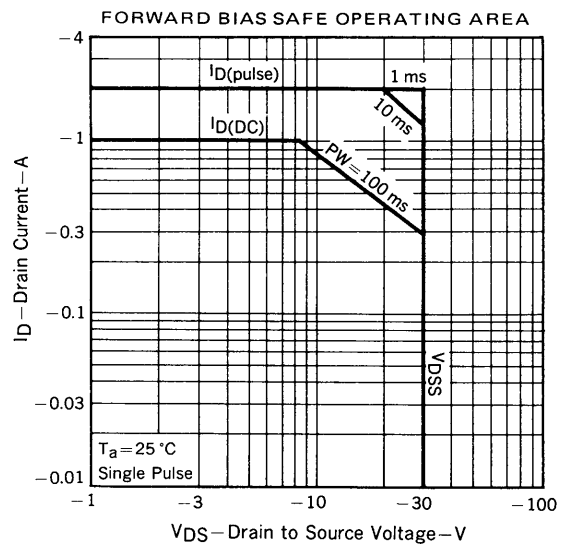
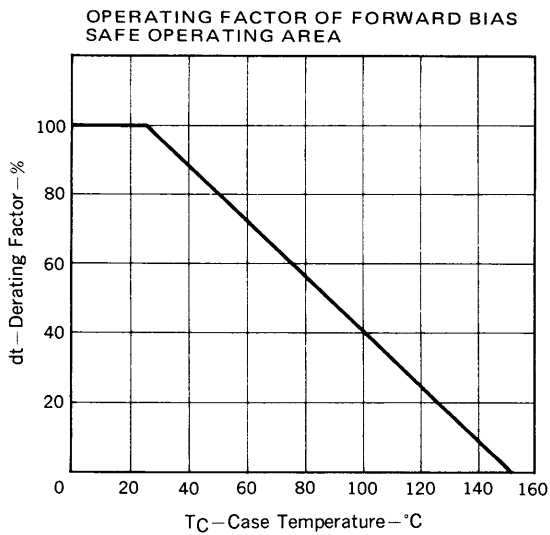

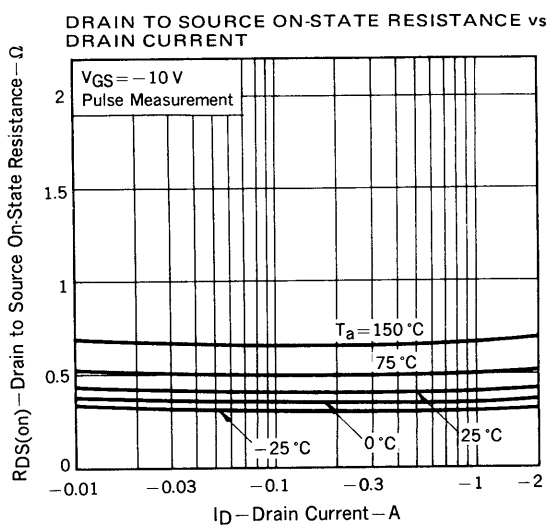
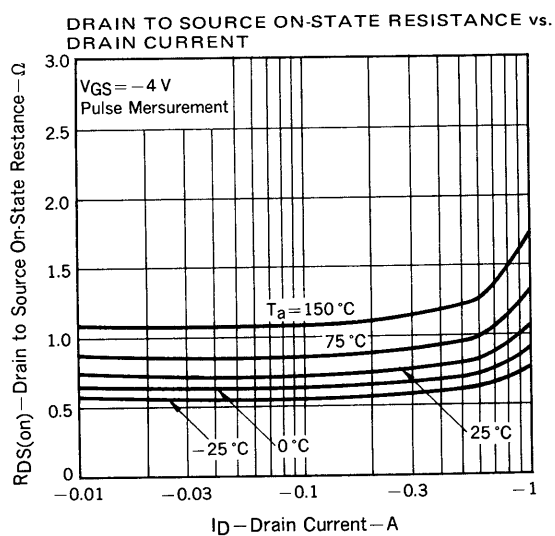
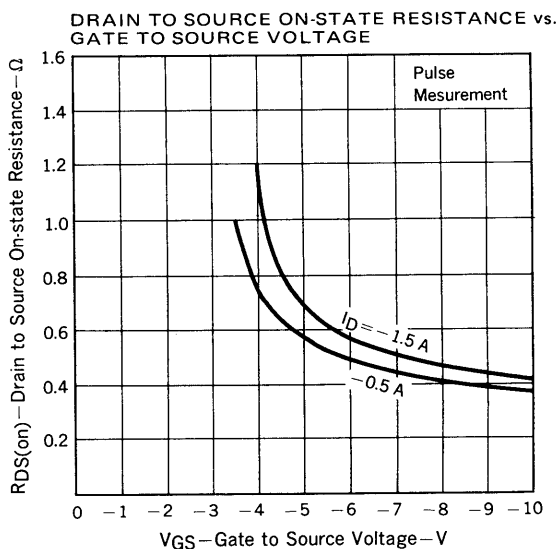
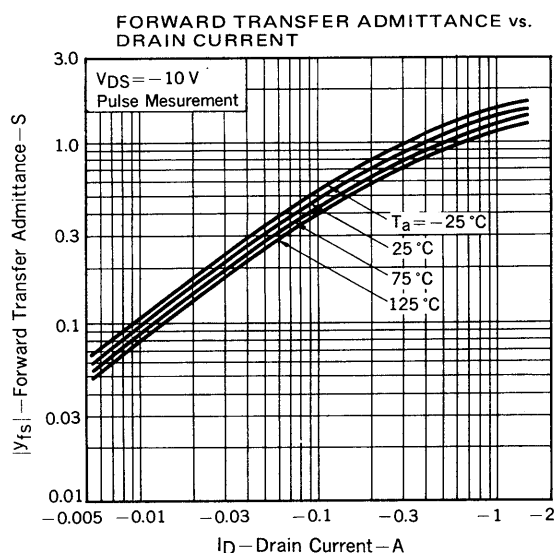
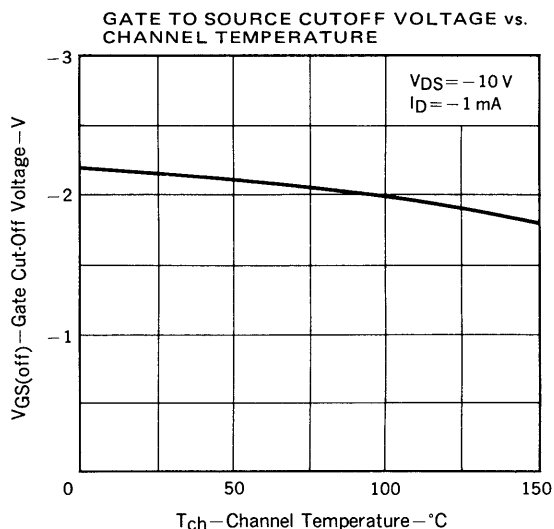
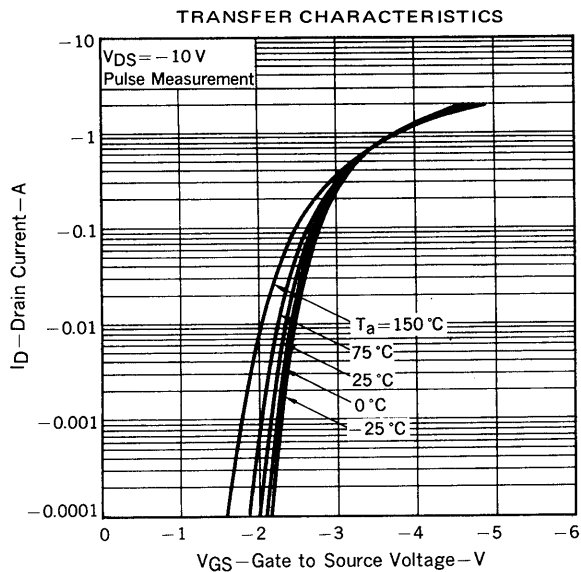

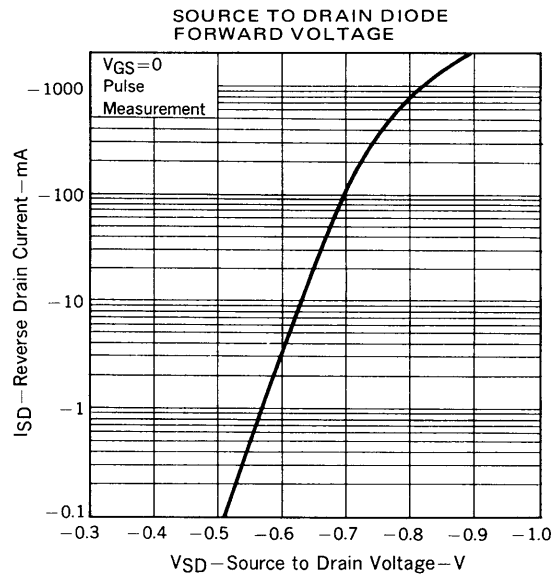
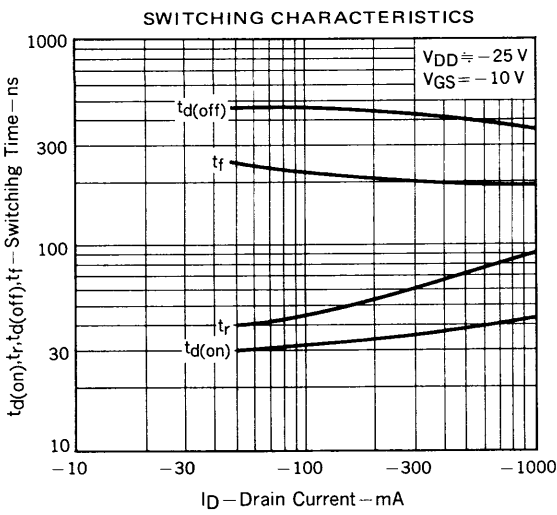
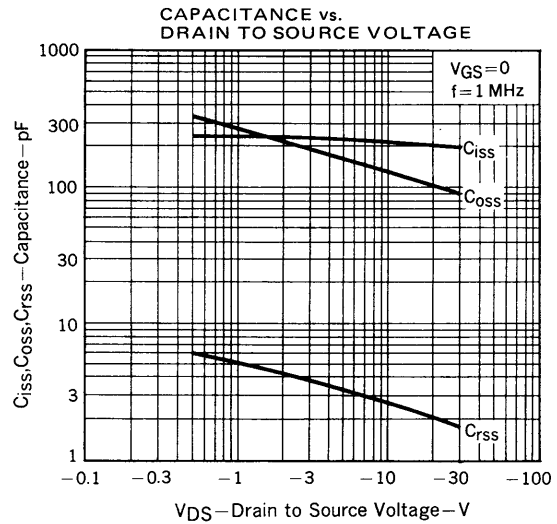
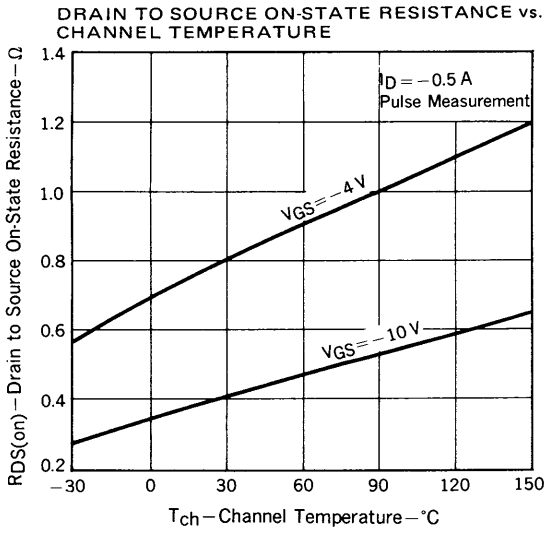

SWITCHING TIME MEASUREMENT CIRCUIT & MEASUREMENT CONDITIONS

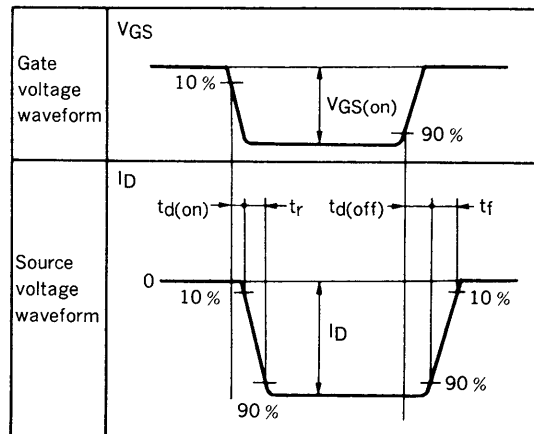
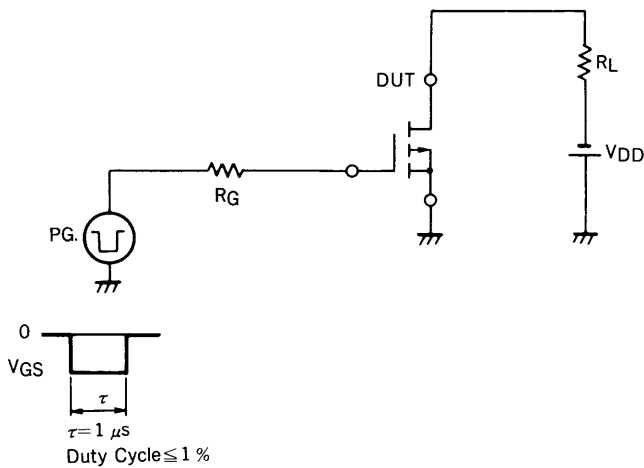

RECOMMENDED SOLDERING CONDITIONS

Solder this product under the following recommended conditions.

For soldering methods or soldering conditions other than those recommended in the table, please consult our NEC salespeople.

Insert type

Soldering method	Soldering conditions	Recommended condition code
Wave soldering	Solder bath temperature: 260 °C max. Soldering time: 10 sec max.	

[MEMO]

No part of this document may be copied or reproduced in any form or by any means without the prior written consent of NEC Corporation. NEC Corporation assumes no responsibility for any errors which may appear in this document.

NEC corporation does not assume any liability for infringement of patents, copyrights or other intellectual property rights of third parties by or arising from use of a device described herein or any other liability arising from use of such device. No license, either express, implied or otherwise, is granted under any patents, copyrights or other intellectual property rights of NEC Corporation or others.

The devices listed in this document are not suitable for use in the field where very high reliability is required including, but not limited to, aerospace equipment, submarine cables, nuclear reactor control systems and life support systems. If customers intend to use NEC devices for above applications or those intended to use "Standard", or "Special" quality grade NEC devices for the applications not intended by NEC, please contact our sales people in advance.

Application examples recommended by NEC Corporation

Standard: Data processing and office equipment, Communication equipment (terminal, mobile). Test and Measurement equipment, Audio and Video equipment, Other consumer products, etc.

Special: Automotive and Transportation equipment, Communication equipment (trunk line), Train and Traffic control devices, industrial robots, Burning control systems, antidisaster systems, anticrime systems etc.