



AURIS



CATALOGUE 2024





CONTENTS

FRONTAL RINGS (SEPTUM/DAITH)	5
SIDE RINGS (NOSTRIL/HELIX).....	7
BASIC BARBELLS, LABRETS AND RINGS.....	10
TOPS WITHOUT GEMSTONES	11
TOPS WITH GEMSTONES.....	13
FANCY CARTILAGE TOPS	20
CRUSH DIAMOND TEXTURE	21
CHAINS HOW-TO	22
STARFALL UP-CHAINS COLLECTION	23
CHAIN-IT COLLECTION	25
NIPPLE BARBELLS.....	28
NAVEL CURVES.....	29
NOVIZIO BY AURIS	30
GEMCHARTS.....	36
OUR GEMS.....	40
WARRANTY.....	41
WHOLESALE F.A.Q.....	42
AURIS BRANDED DISPLAYS AND STANDS	43





2

1

3

1. Marchesa D.
2. Cassiopea
3. Plain, clicker
ring with
Caitlin charm

ALL OUR RINGS ARE AVAILABLE IN:

HOW TO MEASURE?

Inner (wearable)
Diameter: X mm
Size: YxZ mm

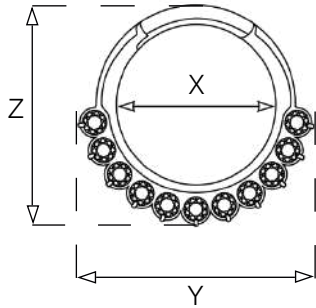

Comes only with a hinge closure!

NO SEAM, NO DAMAGE!

FRONTAL RINGS (SEPTUM/DAITH)



**Marchesa D.
SR-010A**

18g/16g/14g
Wearable height: 5mm
Wearable length: 8mm
Size: 12x19mm
Gems: marquis 2x4mm, chart #1, 3
Pictured with VVS Diamonds

Marchesa D. Cab



SR-010A-CAB

18g/16g/14g
Wearable area: 5mm high, 8mm long
Size: 12x19mm
Gems: Marquis 2x4mm, chart #2,4
Pictured with CHRT/PRMT

Marchesa D. Mix



SR-010A-MIX

18g/16g/14g
Wearable area: 5mm high, 8mm long
Size: 12x19mm
Gems: Marquis 2x4mm, chart #1,2,3,4
Pictured with AMST-fct/PRPT

Marchesa D. Small



SR-010A-SML

18g/16g/14g
Wearable area: 6mm high, 8mm long
Size: 11x17mm
Gems: Marquis 1.5x3mm, chart #1,3

Marchesa O.



SR-010C

18g/16g
Diameter: 10mm
Gems: Marquis 1.5x3mm, chart #1, 3
Size: 16.7x18.8mm
Pictured with BKCZ



Catty



SR-011

18g/16g
Size: 12x12mm
Wearable: 6mm
Gems: 1.25, 1mm,
chart #1, 3

Seth baguette



SR-015-BGT

18g/16g
Wearable: 8mm
Gems: princess: 2mm, chart #3
Baguettes: 3mm,
WCZ, AMST, PKSPH

Helena



SR-024

18g/16g
Diameter: 8/9/10mm
Size: 16x13mm
Gems: 1.5mm, chart #1, 3
Pictured with Black Diamonds

Jupiter clicking



SR-003

16g/14g
Diameter: 8mm
Size: 17x15.8
Gems: 1-1.5mm, chart #1, 3

Tiara



SR-016

18g/16g
Diameter: 7, 8, 9, 10mm
Size: Add 5mm
Gems: 1.25mm, chart #1, 3
Pictured with Black Diamonds

Tiara big



SR-016-BIG

18g/16g
Diameter: 8mm
Size: 13.5x11.5mm
Gems: 2.5mm, chart #1, 3
Pictured with Emeralds

Tiara large



SR-016-LRG

18g/16g
Diameter: 9mm
Size: 15x13.5mm
Gems: 3mm, chart #1, 3
Pictured with Diamonds VVS

Tiara large cab



SR-016-LRG-CAB

18g/16g
Diameter: 8, 10mm
Size: add 7mm
Gems: 3mm cab, chart #2, 4
Pictured with Labradorites

La Pheniche gemmed



SR-007-GEM

18g/16g
Diameter: 8mm
Size: 18.7x14.6mm
Gems: Marquis 1.5x3mm,
round 1.25, chart #1,3

Centurion



SR-008

18g/16g/14g
Diameter: 8/9/12mm
Gems: 1mm, chart #1,3
Size: Add 2mm
Pictured with Rubies/Diamonds
Has 3 rows or gems, front, side,
back, therefore, can be reversible!

Prospero



SR-029

16g/14g
Diameter: 10mm
Gems: 2, 3mm cabs, chart #2,4
Triolin 3mm, tapers 1x2.5mm
WCZ only
Pictured: YLW/WHT gold with
PRMT and WCZ

Cobra



SR-028

18g/16g
Wearable: 6mm
Size: 13.3x12.2mm
Gems: WCZ only
Pictured: WHT/YLW gold

Ariadna



SR-019

16g
Diameter: 8, 10mm
Size: 10.5x12.5mm

Aspiration



SR-009

18g/16g
Diameter: 6, 8mm

You can order this piece single gold
color or yellow/white, rose/white
or yellow/rose



SIDE RINGS (NOSTRILS/HELIX)



Cassiopea

NR-005

18g/16g

Available in following sizes:
5, 6, 7, 8, 9, 10, 11, 12, 13mm

Gems: 1.25mm, chart #1, 3
Pictured with WCZ in
Yellow gold, Diamonds and
Rubies in Platinum.

Cassiopea Tau



NR-016

18g/16g/14g

Diameter: 5, 6, 8, 10mm
Gems: 1.25mm, chart #1, 3
This is a statement piece:
8 mm for flat piercing
10 mm for conch piercing
5, 6 mm for helix/earlobe

Cassiopea-B



NR-005-B

18g/16g

Diameter: 5, 6, 7, 8, 9, 10mm
Gems: reversed 1.5mm, chart #1, 3
chart # 2, 4 under request
Pictured with reversed Emeralds

Cassiopea Beta



NR-015

18g/16g/14g

Diameter: 8, 9, 10mm
Gems: 1.25mm, chart #1, 3

Ptah



NR-006

18g/16g

Diameter: 8, 10mm
Gems: 1mm, chart #1, 3
Has gems on the front
and on the side!

Bleach-1



NR-003-1GEM

16g

Diameter: 5, 6, 7, 8, 9, 10, 11mm
Gem: 1mm, chart #1, 3

Bleach-3



NR-003-3GEM

16g

Diameter: 5, 6, 7, 8, 9, 10, 11mm
Gems: 1mm, chart #1, 3

Vera Ellada



NR-007-ELD

18g/16g

Diameter: 8mm

Freya



NR-008

18g/16g

Diameter: 8, 10mm

Auris ring



NR-020

18g/16g

Diameter: 8, 10mm

Artemida



NR-013

16g

Diameter: 9, 10mm
Gems: princess or reversed princess
2mm, chart #1, 3
Diameter: 6, 7, 8mm
Gems: square cab 2mm, chart #2, 4
or reversed princess 2mm, chart #1,3

Cerberus



NR-014

18g/16g/14g

Diameter: 5, 6, 8, 10mm

Andromeda



NR-025

18g/16g

Diameter: 7mm
Gems: 0.8-2mm, chart #1, 3



Orion belt



NR-027

18g/16g

Diameter: 10mm

Gems: marquise 3x6mm, 2.5x5, 2x4, 1.5x3, princess 2mm; only WCZ or DIA, other colors by request.

This is a pearl for your conch!

Crusader ring



NR-019

18g

Wearable: 8mm

Gem: 1mm, chart #1, 3

When you want to start your nostril with a ring, but the barbell has to be straight!

Nataraja



NR-041-YU

18g/16g

Diameter: 8, 10mm

You can choose different chains: yunona, libera, concordia. Picture with yunona chain.

Reborn



NR-034

18g/16g

Diameter: 5, 6, 7, 8, 9, 10, 11, 12, 13mm

Gems: 1.25mm, chart #1, 3

Has 5 charms: paleo contour, paleo x 2, paleo tiny x 2

Photo

Volar-1



NR-043-1

18g/16g

Diameter: 6, 7, 8, 10, 11mm

Can have plain, matt or crushD texture.

Pictured with crushD

Volar-2



NR-043-2

18g/16g

Diameter: 6, 7, 8, 10, 11mm

Can have plain, matt or crushD texture.

Pictured with matt

Volar-3



NR-043-3

18g/16g

Diameter: 6, 7, 8, 10, 11mm

Can have plain, matt or crushD texture.

Pictured with crushD

Volar-4



NR-043-4

18g/16g

Diameter: 6, 7, 8, 10, 11mm

Can have plain, matt or crushD texture.

Pictured with crushD

Makarease



NR-036

16g/14g

Diameter: 8mm

Size opened: 25x18mm: Size closed: 13.3x12.2mm

Gems: Marquis 1.5x3mm x10, chart #1,3



This statement piece has been designed to adorn coinslot, but looks good in a single flat piercing as well. The charms with spikey marquise fix around the ear due to tiny built-in magnets! So it always wraps the ear tight.



THREADS, PINS & HOOPS

ALL OUR TOPS ARE AVAILABLE IN:

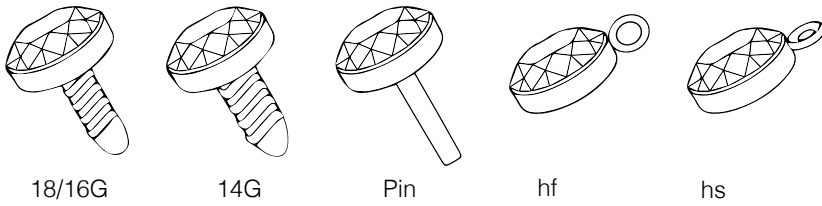

18/16G

14G

Pin

hf

hs

18/16g = 000-120 (fits 16 and 18g Industrial Strength/Anatometal/Neometal labrets)
 14g = metric 1.2 (fits all 14g and 12g labrets)
 Pin (fits most of modern threadless jewelry).
 hf-16g, hf-12g = nipple oriented charm for frontal ring, fits 16g and 18g, or 14g and 12g stud/ring respectively.
 hs-16g, hf-12g = navel oriented charm for side rings, fits 16g and 18g, or 14g and 12g stud/ring respectively.

THREAD/PIN/HOOP PLACEMENT

Sometimes we need a jewel to connect several pieces or to have two threads to fix the piece free of rotation.

You can order many of our standard tops with non-standard threads options to give your ear or navel project really unique look!

Here you can see how you can alternate, for example, our TEG-031-cab Leaf cab piece. Here we have drawn pins everywhere, but it can be a hoop, or even 14g thread if the piece height allows to do that.

When you order a non-standard piece, make sure you understood each other well with the sales manager! If not sure, better draw a scetch. Choice of unconditional threads/pins/hoops adds a small surcharge, double pin/thread/hoop takes it two times.

EXAMPLE:

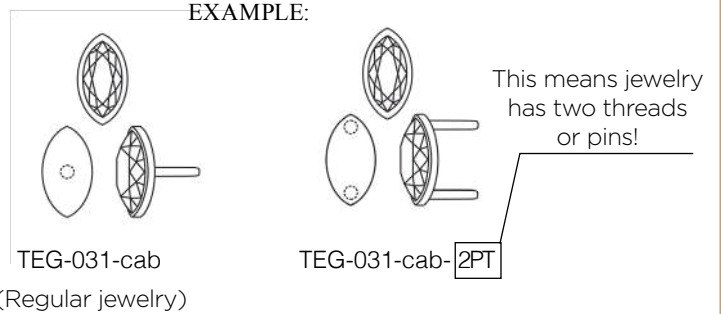

TEG-031-cab

TEG-031-cab-2PT

(Regular jewelry)

HOW TO USE GOLD THREADLESS PROPERLY

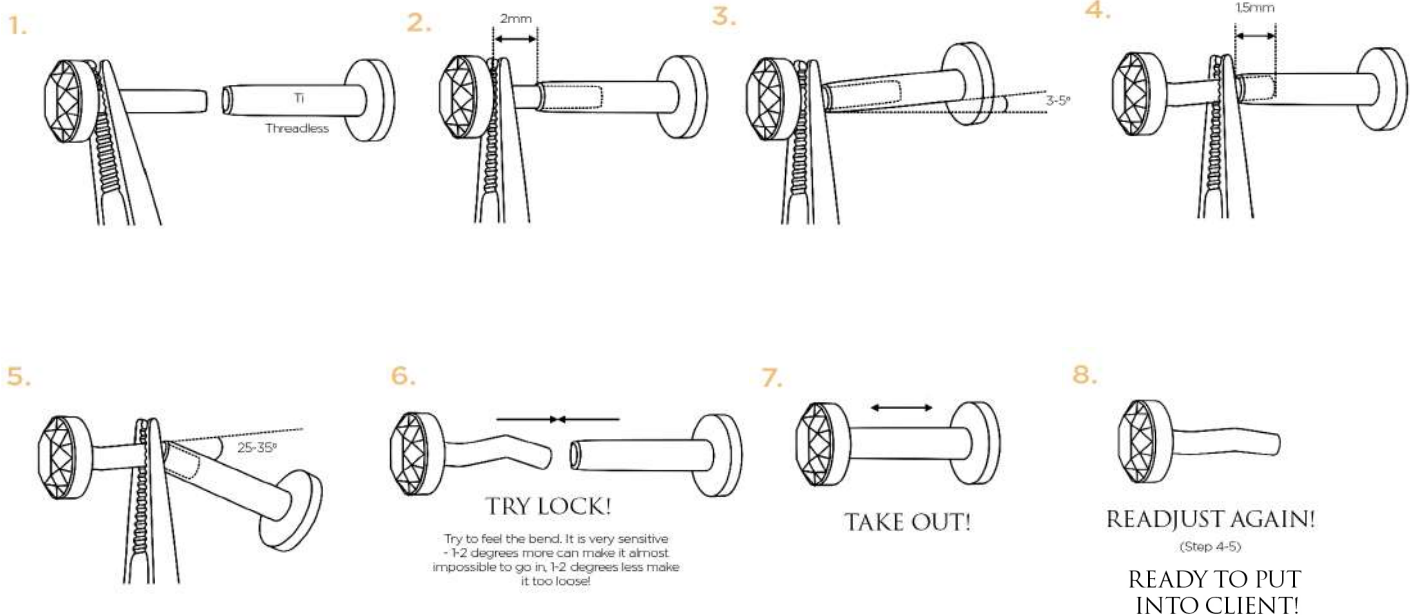

OR JUST USE OUR BENDING TOOL!



OUR STUDS ARE ALL INTERNALLY THREADED OR THREADLESS



COMPATIBLE WITH ALL MAJOR
HIGH-END JEWELRY BRANDS :
INDUSTRIAL STRENGTH,
ANATOMETAL, LEROI, NEOMETAL,
ETC.

OUR METALS COMPONENTS, %

Gold color	AU	AG	PT	CU	ZN
YELLOW 14K	59	6,06	-	30,26	4,68
YELLOW 18K	75	12,5	-	11,5	1
WHITE	59	7,6	2	27,2	4,2
ROSE 14K	59	8	-	33	-
ROSE 18K	75	5,5	-	18,75	-
Platinum	PT	CU	IN	GA	
PLATINUM	95	3	1	1	

- If not specified, we can make any model in White, Yellow, Rose or Black Gold.
- We enhance our White Gold with White Rhodium to gain rich vibrant white color.
- For Black Gold we use Black Rhodium.
- If you polish our 14K gold in house, our metal color warranty doesn't apply.
- Our gold is mined in Russia in legal, responsible and ethic way.

BASIC BARBELLS, LABRETS AND RINGS

Barbell WITHOUT balls



BB-001

Length: 5-50mm
Threaded:
16g (1.2mm), 14g (1.6mm)
Threadless:
18g (1mm), 16g (1.2mm),
14g (1.6mm)

Fixed back labret



TL-001

4, 5, 6, 7, 8, 9, 10mm
Disc: 3.5mm
Threaded:
16g (1.2mm), 14g (1.6mm)
Threadless:
18g (1mm), 16g (1.2mm),
14g (1.6mm)

Labret with interchangeable disk



Post: 4-12mm, 18g/16g/14g,
one side threaded 18g for i/c disc,
the second side either threadless,
or 18/16g threaded.
Disc: 2.5, 3, 4mm, 18g thread
short. Can be replaced
with fancy tops!

Plain clicker ring



BR-004

18g/16g/14g
5, 6, 7, 8, 9, 10, 11, 12mm
Bigger sizes on
demand



TOPS WITHOUT GEMSTONES

Nefertiti



TES-050

1.5x9mm

Amour contour grisant



TES-016-CNT-GRI

6mm

Disc of Dragon



TES-015-DRG

-sml: 3mm
-med: 4mm
-big: 5mm

Clockwork



TES-060

13x4mm
Screws can have alternative gold color.
Pictured as: WHT/YLW

SX



TES-056

4x8mm

Marianna



TES-023

-sml: 4.5mm
-med: 6mm

Teardrop plano



TES-025

-sml: 2x4mm
-med: 2.5x5mm
-big: 3x6mm

TX



TES-055

-sml: 1x6mm
-big: 2x10mm

Ra



TES-031

5mm

Parenthesis



TES-026

-sml: 1x8mm
-med: 1.5x10mm
-big: 2x12mm

Ohm



TES-014

-sml: 5mm
-big: 6mm

Aurisbar



TES-059

-sml: 2x9mm
-big: 2x12mm
Charm has our name on all 4 sides. Top has it on 3 sides.

Pyrastud



TES-030-4-LOW

2x2mm
3x3mm
4x4mm

Isyda



TES-017

-sml: 4*1,7mm
-med: 5.3*3mm
-big: 7.5*5mm

Paleo contour



TES-018-CNT

4.5x3mm

Crescent Moon



TES-003A

3mm

Fenris



TES-051

9.5x9mm
Can be bimetallic (pictured as: YLW/WHT)
Can have right (-R) or left (-L) orientation

Jailbreaker



TES-063

4.5mm

Boeing



TES-048

-sml: 6mm
-big: 10mm

Plus



TES-008

4mm

Battle axe



TES-045

10x7 mm
Can have right (-R) or left (-L) orientation

Pi



TES-049

4mm





1. Honey Lily
2. Orion belt
3. Bloodrunner

TOPS WITH GEMSTONES

Firebird

TEG-017

-sml: 9x3mm
(0.8mm, 1mm
gems,
chart #1, 3)

-med: 10x3mm
(1mm gems,
chart #1, 3)

can have right
(-R) or left (-L)
orientation



TEG-017-MED-L
PICTURED IN WHITE GOLD
WITH EMERALD



TEG-017-MED-R
PICTURED IN 18K YELLOW GOLD
WITH VVS DIAMONDS

3-Prong-set gem

TEG-034

1.5, 2, 2.5, 3, 4mm
Gem: chart #1, 3



Wind Rose small



TEG-016-SML

9mm

Gems: 1.5mm round and
1.5x3mm marquise,
chart #1, 3

Ra gemmed



TEG-039

5mm

Gem: 1.5mm, chart #1, 3
Pictured with Black
Diamond

Rasputin thick



TEG-014A

10x7mm

Gems: 1mm, chart #1, 3

Rasputin with Blink



TEG-014B

10x7mm

Gems: 1mm, chart #1, 3

Voltage gemmed



TEG-055

4x8mm

Gem: 1mm, chart #1, 3
Pictured with Black
Diamond

Elizabeth



TEG-013

-sml: 6x4.5mm

Gems: 0.8mm round and
2x3mm pear, chart #1, 3
-med: 6x8mm

Gems: 1mm round and
3x5mm pear, chart #1, 3

Elizabeth cab



TEG-013-CAB

-sml: 6x4.5mm

Gems: 0.8mm, 2x3mm pear cab
-med: 6x8mm

Gems: 1mm round,
3x5mm pear cab.
round gems: chart #1, 3
pear gems: chart #2, 4
Pictured with WCZ and FLAB

Bloodrunner



TEG-114A



TEG-114B



TEG-114C

4x10mm + dangle:

A: 1.5mm round gem, chart #1, 3
B: 1.5x3mm marquise gem, chart #1, 3
C: 2x3mm pear gem, chart #1, 3
Pictured with WCZ, RDCZ, FPCZ

North Star



TEG-018

7.5x3mm

Gem: princess 2mm,
chart #1, 3

Moonheart Prium



TEG-022

12x4.5mm

Gems: 2, 2.5, 3mm,
chart #1, 3

Moonheart grisant



TEG-023-GRI

11x4mm

Gems: 1.25, 1.5, 2.5mm,
chart #1, 3

Snowflake small



TEG-024-SML

6mm

Gems: 1mm, chart #1, 3
Pictured with Black
Diamonds

Snowflake big



TEG-024-BIG

8mm

Gems: 1.5, 2mm,
chart #1, 3

Diadema



TEG-026A-SML

-sml: 9.5x6mm

Gems: round 1.25, 1.75mm
-med: 10x6.5mm
Gems: round 1.5, 2.25mm,
chart #1, 3
Pictured with Champagne
Diamonds and Emeralds



Anastasia

TEG-028



11x4.5mm
Gems: 0.8mm,
1mm rounds and
3x6mm marquise,
chart #1, 3
Pictured with
WCZ
in Yellow gold,
Champagne
Diamonds and
Emerald in White
Gold

Threeleaf

TEG-012



-tiny: 2.5mm
(1mm gems)
-sml: 3mm
(1.25mm gems)
-med: 3.5mm
(1.5mm gems)
-big: 4mm
(1.75mm gems)
Gems: round,
chart #1, 3

Pictured with VVS Diamonds,
Black Diamonds, Emeralds in
White Gold and Rubies
in Yellow Gold

Antistar



TEG-077

2.5x8mm
Gem: baguette 2x3mm
Only WCZ, AMST, PKSPH
and their sandblasted
versions (-SNB)

Jupiter end



TEG-063-7

15x9mm
Gems: 0.8-1.5mm round,
chart #1, 3
Pictured with Black
Diamonds

Leaf cab grisant



TEG-031-CAB-GRI

-med: 4x2mm
-big: 6x3mm
-large: 8x3.5mm
Gem: Marquis cabs,
chart #2
Pictured with: AMZT,
AMZT, PRMT

Teardrop faceted



TEG-033

-sml: 3x2mm
-med: 5x3mm
-big: 6x4mm
Gem: pears, chart #3
Pictured with: AMCZ,
WCZ, BKCZ

Teardrop cab grisant



TEG-032-GRI

-sml: 3x2mm
-med: 5x3mm
-big: 6x4mm
Gem: pears, chart #2, 4
Pictured with CHRT, MLH,
PRMT

Cascade



TEG-047

-sml: 2x6mm
-big: 2x12mm
Gems: round 1mm,
chart #1, 3
Pictured with Black
Diamonds and Pink
Sapphires

Prong baguette



TEG-076

2x3mm
Gem: baguette 2x3mm
Only WCZ, AMST, PKSPH
and their sandblasted
versions (-SNB)

Unicorn with gem

-L -R



TEG-049

7x9mm
Gem: round 1mm
chart #1, 3
Can be bimetallic
(pictured as: ROS/WHT)
and have right (-R) or left
(-L) orientation

TaperB tiny



TEG-091

1.5x2.5mm
Gem: tap.baguette
1x1.5x2.5
WCZ or DIA only

Fleur-de-Auris



TEG-082

7x6mm
Gems: marquise 1.5x3mm,
round 1.25mm
chart #1, 3

Starwatermoon



-L

TEG-102-WAT

7mm
Gem: 1.5mm round,
chart #1, 3
Can have left (-L)
and right (-R) orientation

Starmoon



-R

TEG-102

7mm
Gem: 1.5mm round,
chart #1, 3
Can have left (-L)
and right (-R) orientation

Gemis



TEG-089

5x21mm
Gems: 0.8-1.5mm
Chart #1, 3

Chrysanta



TEG-079

5,5mm
Gems: 1mm round,
chart #1, 3
Pictured with Black
Diamonds

Avant



TEG-090

7x12mm
Gems: round 0.8mm, 1mm
and marquise 3x6mm,
chart #1, 3





2



1



3



1.Anastasia
2.Iris
3.Avant

Cabochon grisant

TEG-029-GRI

2, 2.5, 3, 4, 5, 6mm
 Gems: round cabs, chart #2, 4
 OR reversed faceted, chart #1, 3
 We also have variety of custom stones under request!



Cabochon grisant
MLH



Cabochon rough
PYR-RGH



AMZT-BLT LAP-BLT
Cabochon bullet



RDCZ-RVS LONCZ-RVS
Cabochon reversed

Zion



TEG-060

9.5x5mm
 Gems: oval 3x5mm, only WCZ
 round 0.8, 1, 1.25mm, chart #1, 3
 Pictured with Rubies and Champagne Diamonds

Pyrrro-1



TEG-052-1

3.5x5mm
 Gems: 3mm cab, chart #2, 4
 OR 3mm faceted reversed, chart #1, 3
 Pictured with reversed WCZ

Pyrrro-2



TEG-052-2

4.5x8mm
 Gems: 4mm cab, chart #2, 4
 Pictured with PRMT

Princess prong



TEG-056

2, 3mm
 Gem: princess 2 or 3mm, chart #1, 3

Bella



TEG-053-BIG

8mm
 Gem: 6mm cab, chart #2, 4
 OR 6mm reversed, chart #1, 3
 Pictured with Tourmalized Quartz

Estrella cab



TEG-054-CAB

-sml: 4.5mm, 2mm gem
 -med: 6mm, 3mm gem
 -big: 8mm, 4mm gem
 Gem: round cab, chart #2, 4
 OR reversed, chart #1, 3
 Pictured with OP17

Estrella faceted



TEG-054-FCT

-sml: 4.5mm, 2mm gem
 -med: 6mm, 3mm gem
 Gem: round, chart #1, 3
 Pictured with Black Diamonds

Pave disk



TEG-066

5x5mm
 Gems: round 1mm, chart #1, 3
 Pictured with VVS Diamonds

Astra



TEG-050-TNY TEG-050-SML-CAB TEG-050-BIG

-tny: 4.5mm (2mm center, 0.8mm petals)
 -sml: 6mm (3mm center, 1mm petals)
 -big: 8mm (4mm center, 1.5mm petals)
 Gems: all the petals are round faceted, chart #1, 3
 In Regular Astra centers are also chart #1, 3
 In Astra cab centers are round cabs, chart #2, 4
 Pictured with WCZ, PPCZ/RQZ

6-petal flower



TEG-011A

-sml: 4.5mm
 Gems: 1.25mm, chart #1,3
 -med: 6mm
 Gems: 1.5mm, chart #1,3
 Pictured as Emeralds and Rubies

Lotus



TEG-059

9x7mm
 Gem: marquise cab 2x4mm, chart #2, 4
 Pictured with WCZ

Lotus dangle



TEG-059-DNG

9x7mm + dangle
 Gems: marquise cab 2x4mm, chart #2, 4
 round 2mm, chart #1, 3
 Pictured as PRMT/WCZ

Amour gemmed



TEG-101

6mm
 Gem: 1.5mm round, chart #1, 3
 Pictured with WCZ

Nefertiti eye



TEG-103

2.5x9mm
 Gem: 1.5mm round, chart #1, 3
 Pictured with WCZ



Iris
TEG-128
 8x14mm

Gems: 1.5x2x4 and 1x1.5x2.5mm tapered baguette, only WCZ or DIA
 1.5x3 and 2x4mm marquise, chart #1, 3
 round 0.8, 1, 1.25mm, chart # 1, 3

Pictured with AMCZ/WCZ in Yellow gold and WCZ in White gold



THE FANCIEST ALTERNATIVE TO PRIUM!

Halleos



TEG-036

2.5x5mm
 Gems: 2mm, chart #1, 3
 Pictured with ARCZ

Ares



TEG-112

Cup: any size of TEG-035
 Dangle: TES-039 big or small
 Base item: 2.5mm gem with Dagger charm
 Chart #1, 3

Bezel Heart



TEG-035-HRT

3mm
 Gem: heart 3mm, WCZ and PCZ only

Cupid



TEG-038

-med: 4mm
 -big: 5mm
 Gem: heart cab, 4mm only with gemchart #4
 5mm with gemchart #4, 5
 Pictured with OP17

Grisant Cup



TEG-035-GRI

1.5, 2, 2.5, 3, 4, 5mm
 Gems: round, chart #1, 3
 Pictured with WCZ in Yellow gold and RUB in White gold

Pylon



TEG-088

-sml: 3x4mm
 -med: 4x5mm
 -big: 6x7mm
 Chart #1, 3
 Pictured with WCZ, AMST-fct, GCZ.

Icarus



TEG-070

5x14mm
 Gems: baguette 2x3mm
 Only WCZ, AMST, PKSPH and their sandblasted versions (-SNB)

Axe gemmed



TEG-073

7x10mm
 Gem: 1mm round, chart #1, 3
 Pictured with RDCZ

Sea Dragon



TEG-085

16x8mm
 Bimetallic
 Gem: 1x1.5x2.5mm baguette, 0.8mm round, chart #1, 3
 Pictured as YLW/WHT, WCZ

Berzerk



TEG-073-DNG

7x10mm + dangle
 Gems: 1mm round, chart #1, 3
 1.5x3mm marquise, chart #3
 Pictured with RDCZ

Sunrise



TEG-074-GRI

5.5x7mm
 Gems: round 1.5mm petals, 2.5mm center, chart #1, 2, 3, 4
 Pictured with Diamonds and Ruby

Woodoo



TEG-131

3.5x8mm
 Gems: baguette 1x1.5x2.5mm, only WCZ or DIA
 round 0.8, 1mm chart #1, 3

Exclamation



TEG-129

3x7mm
 Gem: baguette 1.5x2x4mm, only WCZ or DIA, round 1.5mm chart #1, 3

Crystal joint



TEG-130

3x8mm
 Gem: baguette 1.5x2x4mm only WCZ or DIA

Magister



TEG-106

4x8mm
 Gem: 3.5x8mm marquise cab, chart #2
 Pictured with Black Onyx



Foes jewel

TEG-080



TEG-080

11mm, bi or trimetallic.
Gems: 2mm round center,
0.8mm inner petals,
chart #1, 3
2x4mm faceted or cab
marquis.
Pictured as:
RMS/ WCZ/ MKZT on the
right and RDCZ, WCZ
on the left



TEG-080-CAB

Pinto



TEG-048

6mm
Gems: 1.75mm, chart #1, 3
Pictured with WCZ

Ksiana



TEG-086

14x6mm
Gems: round 1, 1.25, 1.5
mm, chart #1, 3
Pictured with Rubies,
Emeralds and
Champagne Diamonds

Mercury medal grisant



TEG-037-CUP2-GRI

3x6mm
Gems: round 2mm,
chart #1, 3
Square cab 2mm,
chart #2, 4
OR reversed princess,
chart #1, 3.
Pictured with WCZ/OP17

Teardrop medal grisant



TEG-032-CUP2-GRI

6x2mm
Gems: round 2mm,
chart #1, 3
Pear cab 2x3mm,
chart #2, 4
Pictured with RDCZ/OP17

YFT (Your Flight to...)



TEG-134

6x7mm
Gems: 0.8mm round,
chart #1, 3
Pictured with Flags of
South Pole (WCZ) and
Spain (RCZ/AMCZ/
RCZ). May have flags of
Germany, Ireland, France,
Italy, Russia, Mexico, etc.

Lucius



TEG-109

Cup: any size of TEG-035
Dangle: any size
of TES-017
Gem: round 2mm with
small Isyda charm.
Chart #1, 3
Pictured with Black
Diamond

Scipion



TEG-110

Cup: any size of TEG-035
Dangle: TES-018-cnt
Gem: round 2.5mm
with Paleo contour
charm. Chart #1, 3
Can be also a tiny: 1.5mm
gem with tiny paleo
charm

Procion



TEG-113

Cup: any size of TEG-035
Dangle: TEG-047-sml
Gems: round 1, 2mm
Chart #1, 3
Pictured with Black
Diamonds

Triada



TEG-111

Cup: any size of TEG-035
Dangle: any size
of TEG-012
Base item: 2.5mm gem
with tiny Threeleaf charm.
Chart #1, 3

TEG-068-SNB



TEG-068-CAB



TEG-068-FCT-SML

Royal Lily

TEG-068

-sml: 5x7mm
Gems: 1.5x3mm marquis, 1.5mm
round
-med: 7x9mm
Gems: 2x4mm marquis, 2mm
round
chart #1, 2, 3, 4
Pictured with:
MGCZ-snb/WCZ in White Gold,
WCZ in Rose Gold,
RHST/WCZ in Yellow Gold





- 1. Cabochon
- 2. Aqualia
- 3. Astra
- 4. Ares
- 5. Tribead

FANCY CARTILAGE TOPS

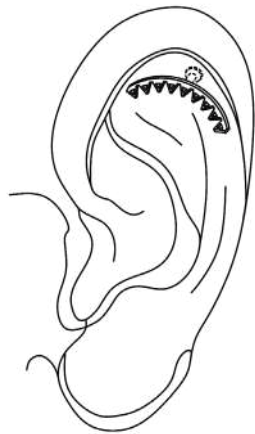

FCT-002

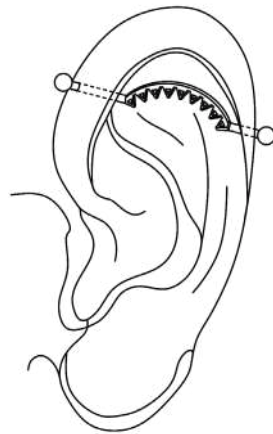

FCT-002-IND



FCT-002-2PT

These ends have been designed in attempt to bring body piercing into the new niche - Niche of high class and complex luxury jewelry.

Some of these tops can be done in at least three options - as a regular top, as a top with two threads which prevents rotating the piece (-2pt), and as industrial element (-ind).

Elfran

-L



FCT-001

14g/16g/pin
20x25mm

Dangle gem: 1.5mm round,
chart #1, 3

Can have left (-L) and right (-R)
orientation

Neos



FCT-013

14g/16g/pin
17x11mm

Can be bimetallic

Flavi



FCT-004

14g/16g/pin
18x8mm

Gems: 3x5mm pear, 1.25, 1.75, 2.5mm
round, chart #1, 3
Can be bimetallic

Elli



FCT-017-01

14g/pin

Gems: round 1.25mmx24
Gemchart #1, 3

This jewel has been created for
designing unconditional ear projects.

You can order it with a thread/pin
under each of first 12 gems. The

code will be like:

FCT-017-1 (pin under 1st gem)

FCT-017-12 (pin under 12th gem)

Pictured as - 1

Ampir



FCT-021

14g/14g*2/pin*2

Gems: marquise 4x6mmx 4,
2.5x5mm x4, 2x4mm x4,

1.5x3mm x6

gemchart #1, 3



CRUSH DIAMOND COLLECTION

The craft of Italian goldsmiths made us smile rad from the first sight when we met this texture at traditional jewelry expo.

That day we had got to know: we need to introduce this texture to body piercing world!

And so we did! We call it CrushD in a short way. It has nothing in common with real diamonds except good sparkling.

Fancy outfit with noble tiny grain new texture looking like a dust of crushed diamonds on the metal surface!

This texture is different and applied manually. It can be an option for all flat gemless tops, for some gemmed tops with flat surfaces, for some tops with volume and clickers like Vera, Aspiration, Desert Sun and so on.

This is all we have as a catalogue, but this is not all we can CrushD! Ask your manager about availability of the desired design with this noble texture!

CrushDisc



TES-015-CRD
2, 2.5, 3, 4, 5mm

Isyda crushD



TES-017-CRD
-med: 3x5mm
-big: 5x8mm

Paleo CrushD



TES-018-CRD
2.5x4mm

Voltage CrushD



TES-034-MED-CRD
4x8mm

Teardrop CrushD



TES-025-CRD
-sml: 2x4mm
-med: 2.5x5mm
-big: 3x6mm

CrushD Cross



TES-038-CRD
-sml: 4x6mm
-med: 5x7mm

Marianna CrushD



TES-023-CRD
-sml: 4.5mm
-med: 6mm

Parenthesis CrushD



TES-026-CRD
-med: 1.5x10mm
-big: 2x12mm

Just O CrushD



TES-044-CRD
5.5, 6, 7, 8mm
This is the overall size, not the inner diameter

Horus CrushD



TES-032-CRD
4mm

Starmoon CrushD



-L

TEG-102-CRD
7mm
Gem: 1.5mm round, chart #1,3
Can have left (-L) and right (-R) orientation

Cassiopea CrushD



NR-017-CRD
18g/16g/14g
6, 8, 10, 11, 13mm

Desert Sun CrushD



NR-002-CRD
18g/16g/14g
8, 10mm

Aspiration CrushD



SR-009-CRD
18/16/14g
6, 8mm

CrushD moon



TES-022-CRD
-med: 5mm
-big: 7mm

Ra CrushD



TES-031-CRD
5mm





it is time to be yourself

TOPS WITHOUT GEMSTONES

Fehu Rune



TES-001A
5x4 mm

Algiz Rune



TES-001B
5x3,9mm

Tribead



TES-007-3-SML
-sml: 2 mm
-med: 3 mm
-big: 4 mm

Colovrat



TES-009
5,5 mm

Phoenix



TES-013
-sml: 7mm
-med: 10mm
Can have right (-R)
or left (-L) orientation

Blank Disk



TES-015
2, 3, 4, 5 mm

Waterdisc



TES-015-WAT
3, 4 mm

Amour Contour



TES-016-CNT
4, 6 mm

Paleo



TES-018
-tny: 1,7x3 mm
-med: 3,7x4 mm

Rhombus



TES-019
2, 3, 4 mm

Water Rhombus



TES-019-WAT
3, 4 mm

Tres contour



TES-021-CNT
-sml: 4 mm
-big: 6 mm

Blank moon



TES-022-PLN
-med: 6x3mm
-big: 7,5x4,3mm

Watermoon



TES-022-WAT
-med: 5,3x3mm
-big: 7,5x3,3mm

Blank Line



TES-024
-sml: 1,5x6mm
-med: 2x9mm
-big: 2,5x2,2mm

WaterLine



TES-024-WAT
-sml: 1,5x6mm
-med: 2x9mm
-big: 12,5x2,2mm

Ball



TES-028
1,5, 2, 2,5, 3, 4, 5
mm

Horus



TES-032
3,7x3,7mm

Seth



TES-033
3,7x4,5mm

Voltage



TES-034
-sml: 4x1,5mm
-med: 8,4x5mm
-big: 14x5mm

Cross



TES-038
- sml: 5,4x3,7mm
- med: 7x4,8mm

Dagger



TES-039
- sml: 4,7*2,3mm
-big: 10,5x3,6 mm

Star



TES-040
4.5 mm

Anchor



TES-042
-sml: 6x5 mm
-big: 8x8 mm

Just O top



TES-044
5,5, 6, 7, 8 mm

Avion



TES-047
5x7 mm

Tiny Heart



TES-053-PLN-SML
2,5 mm

GEMMED TOPS

Moon priestess



TEG-006-B
7x3,7 mm
Gems: 1 mm
WCZ only

Rock Star



TEG-009
6x6 mm
Gems: 1,5 mm
WCZ only

6-petal flower



TEG-011B
5 mm
Gems:
1,75mm/1,25mmx6
6 mm
Gems:
2mm/1,5mmx6
WCZ only

Moonheart



TEG-021
10x4 mm
Gems: 1,5x2 mm
1,75x2 mm
2,25 mm
WCZ only

Opal Cab



TEG-029
3, 4, 5 mm
ONLY: OP17, OP26,
OP27

Quartz



TEG-030
5x5 mm
Gems: 2x2 mm
WCZ only

Teardrop cab



TEG-032
- sml: 2x3 mm
- med: 3x5 mm
ONLY: OP17, OP26,
OP27

Square Opal Cab



TEG-037
- sml: 2 mm
Gems: 2x2 mm
- med: 3 mm
Gems: 3x3 mm
ONLY: OP17, OP26,
OP27

Horus gemmed



TEG-040
- sml: 3 mm
Gems: 1,25mm
- med: 4 mm
Gems: 1,5 mm
WCZ only

Seth gemmed



TEG-041
- sml: 3 mm
Gems: 1,25mm
- med: 4 mm
Gems: 1,25 mm
WCZ only

Madalin



TEG-044
10x4 mm
Gems: 1,25 mm x 5
WCZ only

Concentric



TEG-045
4,7x4,7 mm
Gems: 1,75 mm
WCZ only

Centaura



TEG-046
7,5x3 mm
Gems: 2mm;
0,8mmx3
WCZ only

FRONTAL RINGS (SEPTUM/DAITH)

Persephona



SR-002
18g/16g/14g
8 mm
Gems: 1.5x6 mm,
WCZ only

Trio



SR-004-SML
18g/16g
6, 7, 8, 10 mm

Trio big



SR-004-BIG
14g
7, 8, 9, 10 mm

Marchesa-N



SR-010-N
18g
8,2x5mm

Pegasus shoe 2



SR-025
18g/16g/14g
8 mm
Inside sections may be
altered with White or
Black Rhodium

Eclipse



SR-026
18g/16g/14g
10 mm

Pegasus shoe 7



SR-025-7
18g/16g/14g
8 mm
Inside sections may be
altered with White or
Black Rhodium

Desert Sun



NR-002
18g/16g/14g
6, 8, 10 mm

SIDE RINGS (NOSTRILS/HELIX)

Runir



NR-011
18g/16g/14g
8 mm

Cassiopea Null



NR-017
18g/16g/14g
6, 8, 10, 11 mm

Cassiopea Omega



NR-018
18g/16g/14g
8, 9, 10 mm

Stardust



NR-021
18g/16g/14g
8 mm
Gems: 1,25mmx11
WCZ only

Excitement



NR-001
18g/16g/14g
6, 8, 10 mm

Amfitrita



NR-035
18g/16g/14g
8 mm

Aspiration



SR-009
18g/16g/14g
6, 8 mm

Vyunok



NR-010
18g/16g/14g
8, 10, 11 mm
Gems: 2,5 mm
WCZ only

Seam ring



BR-001
18g/16g
6, 7, 8, 9, 10 mm

Vera



NR-007
18g/16g/14g
6, 7, 8, 9, 10 mm

CHAINS HOW-TO

Basically, we have five types of chains, they are not always in stock, but we are trying to keep them up!

Yunona chain



-YU OPTION

1mm

Libera chain



-LB OPTION

0.9mm

Concordia chain



-CC OPTION

1.2mm

Bastet chain



-BT OPTION

1mm

We can do almost any our chained stuff with Yunona and Kronos; Libera, Concordia and Bastet are welded to a hoop or a top.

Single Up-chain



UC-005

Double Up-chain



UC-003

Triple Up-chain



UC-004

Can be made to fit 16g or 12g posts - specify this while ordering!



UC-005-CHARM
Pictured with -BT



UC-003-CHARM
Pictured with -YU



UC-004-CHARM
Pictured with -YU chain

HOW TO MEASURE UPCHAIN?

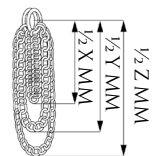
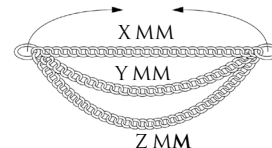

WHERE TO APPLY UPCHAINS

Up-Grade your existing piercing and jewelry!



Trendy nostril symmetry might become a single jewelry project with a chain connecting those two jewelry pieces with its jump rings!



Connect two or more your existing piercing, totally enchanting the way they look!



Just insert your labret/barbell into two jump rings of Up-Chaing from each side! Being classy had never been so easy!



STARFALL UP-CHAINS COLLECTION

Amour up-chain



UC-021-TES-016-CNT

16g, 14g
20-30mm

Wintour



UC-014-YU

16g, 14g
32/9/5mm

Arlekino charm



UC-015-YU-CHARM

16g, 14g, 12g
9/16mm

Aqualia



UC-016-YU

16g, 14g
38/16/7mm;
Gems: pear 3x5mm,
round 1.5mm
Pictured with RDCZ
Chart #1, 3

Selendis



UC-018-YU

16g, 14g
20-30mm;
Gems: baguette 2x3mm,
tap. baguette 1x1.5x2.5mm
Chart #1, 3

Seth A up-chain



UC-019-A-YU

16g, 14g
20mm

Seth C up-chain



UC-019-C-YU

16g, 14g
20mm

Tassadar-2



UC-020-KR-2

16g, 14g
20-25mm

Ellanor



UC-022-YU

16g, 14g
30/35/40mm
Gems: round 1.5mm,
2.5mm
Chart #1, 3

Kali



UC-023-YU

16g, 14g
20-30mm

Briggitte



UC-025-YU

16g, 14g
20-30mm;
ball 1.5mm
Gems: round 1.5mm,
pear 2x3mm
Chart #1, 3

Aldaris charm



UC-026-YU-CHARM

16g, 14g, 12g
18mm tap baguette
Gems: 1x1.5x2.5mm
Chart #1, 3

Elendil Upchain



UC-024-YU

16g, 14g
20-30mm

Beladonna charm



UC-010-YU-CHARM

16g, 14g, 12g
10/18mm
Gems: tap.baguette
1x1.5x2.5mm
Chart #1, 3





1-3. 3-prong
4. Adrian

CHAIN-IT COLLECTION



TEG-099-2-GRI-YU-L

Caitlin



TEG-099-2-GRI-BT-R



TEG-099-3-GRI-YU-L

TEG-035-gri with 2 (-2) or 3 (-3) loose chains
Gems: 2, 2.5, 3mm, chart #1, 3
Can have left (-L) or right (-R) orientation,
Yunona (-yu) or Bastet (-bt) chains.

Elemence



TEG-104-GRI-YU

4, 5, 6mm
TEG-029-gri with a
wrapping Yunona (-yu)
or Libera (-lb) chain.
Pictured with PRL and
Yunona, LAP and Yunona
chain.

Estrellemence



TEG-054-BIG-YU

8mm
Gems: 4mm cabochon
chart: #2, 4
Can have Yunona (-yu)
or Libera (-lb) chain.
Pictured with RQZ and
Yunona

Adrian



TEG-100-BIG-YU-L



TEG-100-SML-KR-R



TEG-100-SML-YU

-sml: 2x6mm (5 chains)
-big: 2x12mm (9 chains)
Gems: 1mm, chart #1, 3
Can have central, left (-L) or right (-R) orientation,
Yunona (-yu) or Bastet (-bt) chains.

Butterfly



ICD-001-TEG-033-MED

This jewel is a TES-026-BIG
Parenthesis with a chain
and running charm
on it. Charm may be any of
our tops! Here pictured
ICD-001-YU-TEG-033-med
with Yunona (-yu)
and Ruby.

Cerrera



ICD-003

The base is also
a TES-026-BIG
Size: 12x29mm

Bellemence



TEG-053-BIG-YU

8mm
Gem: 6mm cabochon
chart: #2
Can have Yunona (-yu)
or Libera (-lb) chain. Can
have plain or CrushD
(-crd). Pictured with
Yunona (-YU) chain, plain
texture and LAP.

Lucile



TEG-095-BT

TEG-088-med with 6mm
of Bastet loose chain on
the bottom.
Gem: 2x4mm marquis,
chart: #1, 3

Nemertea



TEG-097-YU

TEG-012-med
with TEG-033-sml charm
Gems: round 1.5mm,
chart #1, 3
pear 2x3mm,
chart #1, 3
Pictured with
LONCZ/ARCZ

Honey Lily



TEG-105-YU

bigger TEG-068 with
upside down
TEG-033-sml charm
Gems: marquis 2x4mm,
chart #1, 2, 3, 4
pear 2x3mm
and round 2mm,
chart #1, 3

Kromwell



TEG-098-YU

TEG-035 cup with
1.2x6mm bar
on 5mm chain.
Base item: 2.5mm gem
with Yunona chain,
chart #1, 3
You can choose any of
our chain pattern.



Kselian



TES-058-SML-CRD-YU-L TES-058-MED-PLN-YU TES-058-SML-WAT-YU-R

-sml: 2x6mm (5 chains)
-med: 2x9mm (7 chains)

Can have plain, crushD (-crd) or Water (-wat) texture; central, left (-L) or right (-R) orientation, Yunona (-yu) chains.

Arctur



TES-057-YU

2mm ball with 1.2x6mm bar on 5mm chain.
Can have any our chain pattern.

Francine



TEG-094-1, TEG-094-2

TEG-012-med with 1 or 2 chains
Can only have Yunona chain
Gems: round 1.5mm, chart #1, 3

Livia C



TEG-093C-BT-L

TEG-093C-YU-R

4x12mm + chains
Gems: 2, 2.5, 3mm, chart #1, 3

Can have left (-L) or right (-R) orientation, Yunona (-yu), Bastet (-bt), Libera (-lb) chains.

2-chain clicker ring



SR-021-LB

18g/16g/14g
Diameter: 5, 6, 7, 8, 9, 10, 11, 12mm

You can vary different chains: -yu/lb for example.

1-chain clicker ring



SR-020-YU

18g/16g/14g
Diameter: 5, 6, 7, 8, 9, 10, 11, 12mm

You can choose any our chains.

Atera



NR-031-YU

16g
Diameter: 9, 10mm
Gems: princess or reversed princess 2mm, chart #1, 3
Diameter: 6, 7, 8mm
Gems: square cab 2mm, chart #2, 4
or reversed princess 2mm, chart #1, 3
round 2mm, chart #1, 3

Yara



NR-033

18g, 16g, 14g
Diameter: 8, 9, 10mm
Gems: pear 2x3mm
chart #1, 3

Yariana



NR-038

18g, 16g, 14g
Diameter: 8, 9, 10mm

SR-020-YU-0,47



SR-020-YU



SR-020-YU-X1,5



SR-020-YU-X2



CHAIN LENGTHS:

Add any chain rings to the code:
-x0,47 to make it with 48% shorter chain
-x1,5 to make it with 67% longer chain
-x2 to make it with 100% longer chain
Standard with 1 chain -x1
Standard with 2 chain -x1 + x1,5
Standard with 3 chain -x1 + x1,5 + x2

SR-021-YU

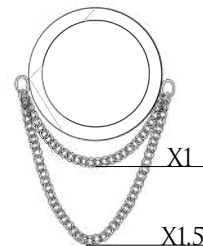

X1

X1,5

NR-038-YU

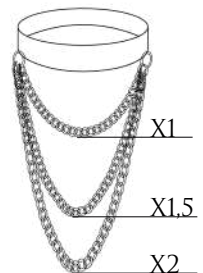

X1

X1,5

X2

CHAIN PATTERNS:

Add to the code:
-YU to make it with Yunona chain
-BT to make it with Bastet chain
-Lb to make it with Libera chain
Note: not every design may be done with every chain pattern



ENCHANCING CHARMS

Upgrade your existing piercing without even taking jewelry out!
Now you can order ANY our top as a charm!

It can look front or side (hf and hs relatively).

Just open your ring, or unscrew your labret, put a charm hoop onto the post and close it back. Voila! The totally new enchanced look of your jewelry!

We make charms in two hoops sizes: one (16-hf and 16-hs) accurately fits 16g and thinner studs. The other one (12-hf and 12-hs) fits 14g and 12g studs and - which is important, fits our Cassiopea ring!

LABRET WITH PHOENIX CHARM AND 3-PRONG-SET GEM

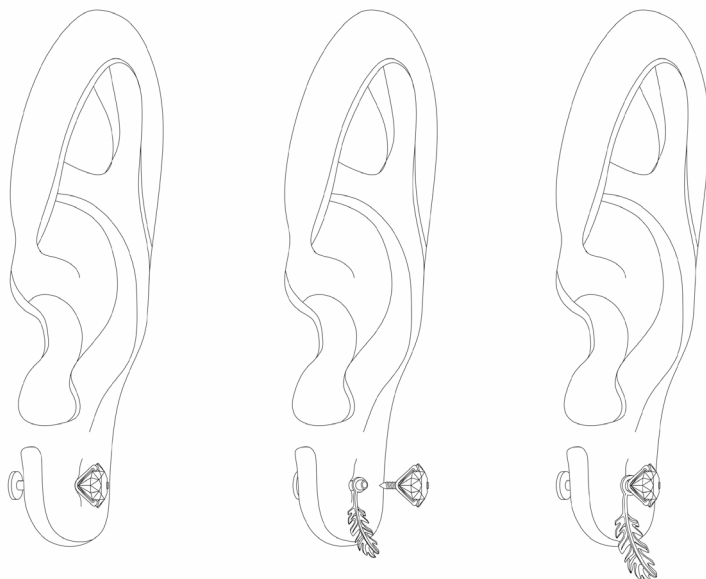

CHARM: TES-013-L 16-HS ON A LABRET WITH OUR TEG-034 3-PRONG TOP

PHOENIX CHARM ON A CLICKERING

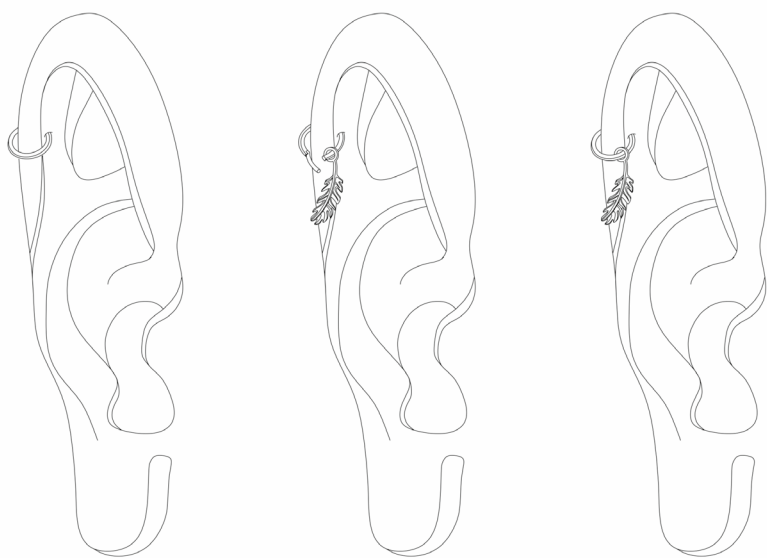

CHARM: TES-013-R 16-HS ON OUR BR-004 CLICKERING

If you want your charm hanged on a chain, use the following code:

UC-005-charm-yu-8mm-TES-013-L

Where UC-005-charm indicates that you're ordering a chain with a hanging charm

-yu-8mm indicates that you're ordering Yunona chain 8mm long

and -TES-013-L indicated that you're ordering the feather left hanging on the bottom.

Works especially good when you want to do something, but you don't want a new piercing, and don't want to take away existing jewelry.

Hint: If you order an up-chain with 16g hoops and a charm with 12-hs hoop, you can simply put a chain into charm hoop and therefore, get an up-chain with running charm of your choice!

Designing of new jewelry had never been as easy as now!



NIPPLE BARBELLS

La Pheniche Nipple Clicker



NB-005

Wearable: 12mm
Thickness: 1.6mm
Size: 23x14mm

Bliss barbell



NB-008

Length: 9-25mm
Thickness: 1.6mm
Threadless only
Gems: -med: 3mm round
-big: 4 mm round, chart #1, 3

Jupiter Nipple clicker



NB-011

Wearable: 11mm
Thickness: 1.6mm
Size: 21x16mm;
Gems: round 1, 1.25, 1.5, 2mm,
chart #1, 3

Lily Nipple barbell



NB-013

Length: 9-25mm
Thickness: 1.6 mm.
Threadless only
Gems: 2x4mm marquise, 2mm round,
chart #1, 3

Sunrise barbell



NB-0014

Length: 9-25mm
Threadless only
Thickness: 1.6mm
Gems: 2.5mm round,
chart #1, 2, 3, 4
1.5mm round, chart #1, 3

Aurora nipple clicker



NB-002

Wearable: 11x6mm
Size: 17x11mm
Wearable: 15x5mm
Size: 19.5x10.9mm
Thickness: 1.6mm
Gems: 2mm round,
chart #1, 3

La Moncy barbell



NB-012

Length: 12-16mm
Threadless only
Thickness: 1.6mm
Gems: 4mm cabochon,
chart #2, 4,
3x1.5mm marquise, 3 mm round,
chart #1, 3

Ana-Marchesa



NB-010-2

Wearable: 15x8mm
Size: 28x16.8mm
Thickness: 1.6mm
Gems: chart #1, 3
Pictured with WCZ/RCZ and BKCZ

Wink barbell



NB-009

Length: 9-25mm
Thickness: 1.6mm
Threadless only
Gems: 4mm cabochon
Chart #2, 4



NAVEL CURVES DESIGNS

Classica



NC-002

Length: 8mm
Thickness: 1.6mm
Gems: 4 and 6mm round
Gemchart #1, 3

Loraine



NC-009

Length: 11mm
Thickness: 1.6mm
Gems: 4, 6mm round
Gemchart #1, 3

Dimension



NC-011

Length: 10mm
Thickness: 1.6mm
Gems: 2.5x5mm baguette
WCZ only

NAVEL CURVES CONSTRUCTOR

1. INTERCHANABLE NAVEL CURVES

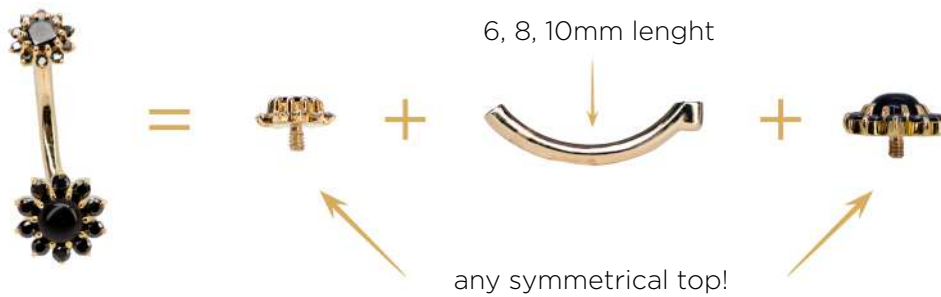

TEG: 029, 034, 035, 050, 011, 080, 016, 024, 048, 053, 054, 066, 079, 104, 132, 141
TES: 009, 015, 023, 028, 030-0

You can order separate navel curves with the code **NCI-01**, in various sizes or colors, separate 14g threaded tops, and change them due to your customer requirements!

2. FIXED BOTTOM NAVEL CURVES

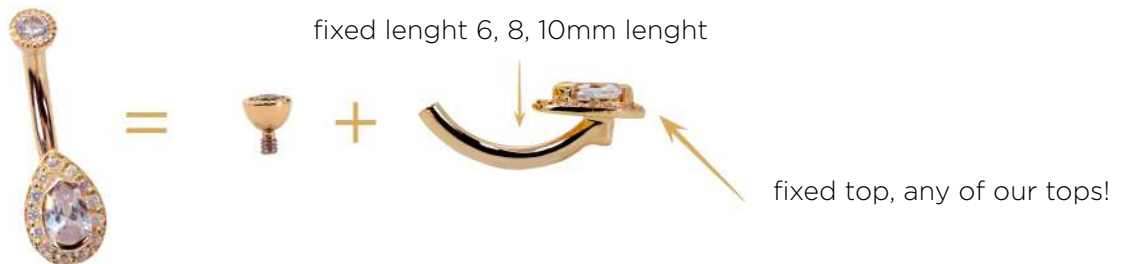





















These Navel Curves are final with size and welded bottom decoration. But at least, you can choose any of our tops, even non symmetrical, and we will weld them at a correct angle.



GEMCHART #1

PRECIOUS GEMS

								
	Diamond	DIA	0,8, 1, 1,25, 1,5, 1,75, 2, 2,5, 3, 4, 5, 6	1,5x1,5, 2x2, 3x3	2x3, 5x3	1,5x3, 2x4, 3x6	2,5x1,5x1, 4x2x1,5	-
	Black diamond	BKDIA	1, 1,25, 1,5, 2, 2,5, 3	-	-	2x4	-	-
* 	Ruby	RUB	1, 1,25, 1,5, 1,75, 2, 2,5, 3, 4, 5, 6	2x2, 3x3	5x3	2x4, 3x6	-	-
* 	Emerald	EMER	1, 1,25, 1,5, 1,75, 2, 2,5, 3, 4, 5, 6	2x2, 3x3	5x3	2x4, 3x6	-	-
* 	Blue sapphire	BLSPH	1, 1,25, 1,5, 1,75, 2, 2,5, 3, 4, 5, 6	2x2, 3x3	5x3	2x4, 3x6	-	-
* 	Pink sapphire	PKSPH	1, 1,25, 1,5, 2, 2,5, 3	2x2	2x3	1,5x3, 4x2	-	-
	Clear sapphire	WSPH	1, 1,25, 1,5, 3, 4	-	-	1,5x3	2,5x1,5x1	-
* 	Amethyst	AMST-FCT	1,25, 1,5, 1,75, 2, 2,5, 3	2x2, 3x3	5x3	1,5x3, 4x2, 5x2,5, 6x3, 8x3,5	-	2x3
* 	London topaz	LONTOP-FCT	1,25, 1,5, 2, 2,5, 3	2x2, 3x3	5x3	4x2, 6x3	-	-
* 	Garnet	GAR-FCT	1, 4	2x2	-	-	-	-
* 	Blue topaz	BLTOP-FCT	1,25, 1,5, 1,75, 2, 2,5, 3	2x2, 3x3	5x3	4x2, 5x2,5	-	-
* 	Rhodolite	RDLT-FCT	1,25, 1,5, 2,5	-	5x3	4x2, 5x2,5	-	-
* 	Smoky quartz	SMOZ-FCT	1,25, 1,5, 1,75, 2, 2,5, 3, 4	2x2, 3x3	-	-	-	-
* 	Tsavorite	TSV	1,25, 1,5, 2	-	-	1,5x3, 4x2	-	-

* Due to genuine nature of this gemstone, color may vary!



GEMCHART #2

NATURAL FLATBACK STONES























								SNB	RGH	BLT
	Uvarovite	GRNDZ	3, 4, 5, 6	-	-	3x5	4x2	-	+	-
	Amazonite	AMZT	2, 2.5, 3, 4, 5, 6	6x4	2x2, 3x3	2x3, 5x3, 6x4	1.5x3, 4x2, 6x3, 8x4	-	-	+
	Amethyst	AMST	2, 2.5, 3, 4, 5, 6	6x4	2x2, 3x3	2x3, 5x3, 6x4	1.5x3, 4x2, 6x3, 8x4	+	-	+
	Black onyx	BKOX	2, 2.5, 3, 4, 5, 6	6x4	2x2, 3x3	2x3, 5x3, 6x4	1.5x3, 4x2, 6x3, 8x4	+	-	+
	Charoite	CHRT	2, 2.5, 3, 4, 5, 6	6x4	2x2, 3x3	2x3, 5x3, 6x4	1.5x3, 4x2, 6x3, 8x4	-	-	-
	Clear quartz	CLROZ	2, 2.5, 3, 4, 5, 6	6x4	3x3	2x3, 5x3, 6x4	1.5x3, 4x2, 6x3, 8x4	+	-	+
	Garnet	GAR	2, 2.5, 3, 4, 5, 6	6x4	2x2, 3x3	2x3, 5x3, 6x4	1.5x3, 4x2, 6x3, 8x4	+	-	-
	Howlite	HWLT	3, 4, 5, 6	6x4	3x3	2x3, 5x3, 6x4	4x2, 6x3, 8x4	-	-	+
	Labradorite	LAB	3, 4, 5, 6	6x4	3x3	2x3, 5x3, 6x4	4x2, 6x3, 8x4	-	-	+
	Lapis	LAP	2, 2.5, 3, 4, 5, 6	6x4	2x2, 3x3	2x3, 5x3, 6x4	1.5x3, 4x2, 6x3, 8x4	-	-	-
	Malachite	MLH	2, 2.5, 3, 4, 5, 6	6x4	2x2, 3x3	2x3, 5x3, 6x4	1.5x3, 4x2, 6x3, 8x4	-	-	+
	Pearl/Mother of pearl*	PRL/PRMT	2, 2.5, 3, 4, 5, 6	6x4	2x2, 3x3	2x3, 5x3, 6x4	1.5x3, 4x2, 6x3, 8x4	-	-	-
	Pyrite	PYR	3, 4, 5, 6	6x4	3x3	2x3, 5x3, 6x4	4x2, 6x3, 8x4	-	+	+
	Rainbow moonstone	RMS	2, 2.5, 3, 4, 5, 6	6x4	3x3	2x3, 5x3, 6x4	4x2, 6x3, 8x4	-	-	+
	Rhodochrosite	RHST	2, 2.5, 3, 4, 5, 6	6x4	3x3	2x3, 5x3, 6x4	1.5x3, 4x2, 6x3, 8x4	-	-	-
	Rose quartz	RQZ	2.5, 3, 4, 5, 6	6x4	3x3	2x3, 5x3, 6x4	4x2, 6x3, 8x4	+	-	+
	Rutilated Quartz	RUTQZ	4, 5, 6	6x4	-	5x3, 6x4	4x2, 6x3, 8x4	-	-	+
	Pegmatite	PGMT	3, 4, 5, 6	6x4	3x3	2x3, 5x3, 6x4	4x2, 6x3, 8x4	-	+	-
	Turquoise	TQ	1.5, 2, 2.5, 3, 4, 5, 6	6x4	2x2, 3x3	2x3, 5x3, 6x4	1.5x3, 4x2, 6x3, 8x4	-	-	-

* Mother of Pearl (PRMT) replaces Pearl (PRL) if gem is not round



GEMCHART #3













CUBIC ZIRCONIA GEMS

								
	White CZ	WCZ	0,8, 1,125, 1,5, 1,75, 2, 2,5, 3, 4, 5, 6	1,5x1,5, 2x2, 3x3	3x2, 5x3, 6x4	1,5x3, 4x2, 6x3	3x3	1,5x3, 4x2, 6x3
	Amber CZ	AMCZ	1,125, 1,5, 2, 2,5, 3, 4, 6	-	5x3	4x2	-	1,5x3
	Black CZ	BKCZ	1,125, 1,5, 1,75, 2, 2,5, 3, 4, 6	2x2	3x2	4x2, 6x3	-	1,5x3, 6x3
	Red CZ	RCZ	0,8, 1,125, 1,5, 1,75, 2, 2,5, 3, 6	1,5x1,5, 2x2	3x2, 5x3	2x4	-	1,5x3, 6x3
	London Blue Dark	LONCZ	1,25, 1,5, 1,75, 2, 2,5, 3, 4, 6	2x2, 3x3	3x2, 5x3, 6x4	2x4, 6x3	-	1,5x3, 6x3
	Arctic Blue CZ	ARCZ	0,8, 1,125, 1,5, 1,75, 2, 2,5, 3, 6	1,5x1,5, 2x2	3x2, 5x3	1,5x3, 4x2, 6x3	-	1,5x3, 6x3
	Fancy Purple CZ	FPCZ	0,8, 1,125, 1,5, 1,75, 2, 2,5, 3, 6	1,5x1,5	3x2, 5x3	1,5x3, 4x2	-	1,5x3, 6x3
	Fancy Champagne CZ	FCCZ	1,125, 1,5, 2, 2,5, 3, 4, 6	2x2, 3x3	3x2, 5x3	4x2, 6x3	-	1,5x3, 4x2, 6x3
	Mint CZ	MGCZ	0,8, 1,125, 1,5, 1,75, 2, 2,5, 3, 4, 6	2x2	3x2, 5x3	1,5x3, 4x2, 6x3	-	1,5x3, 4x2, 6x3
	Fancy Pink CZ	PCZ	0,8, 1,125, 1,5, 1,75, 2, 2,5, 3, 4, 6	1,5x1,5, 2x2	3x2, 5x3	1,5x3, 4x2, 6x3	3x3	1,5x3, 6x3
	Fancy Blue CZ	FBCZ	0,8, 1,125, 1,5, 2, 2,5, 3, 6	-	5x3	6x3	-	1,5x3, 6x3
	Greyish Blue CZ	GBCZ	0,8, 1,125, 1,5, 1,75, 2, 2,5, 3, 4, 6	-	-	1,5x3, 4x2, 6x3	-	1,5x3, 6x3
	Red Dark CZ	RDCZ	0,8, 1,125, 1,5, 1,75, 2, 2,5, 3, 6	-	3x2, 5x3, 6x4	1,5x3, 4x2	-	1,5x3, 4x2, 6x3
	Caramel CZ	CCZ	1,125, 1,5, 2, 2,5, 3, 6	-	-	-	-	1,5x3
	Spring Green CZ	SGCZ	0,8, 1,125, 1,5, 1,75, 2, 2,5, 3, 6	-	3x2, 5x3	1,5x3, 4x2	-	1,5x3, 4x2, 6x3
	Purplish Pink CZ	PPCZ	0,8, 1,125, 1,5, 1,75, 2, 2,5, 3, 6	2x2, 3x3	3x2, 5x3	1,5x3, 4x2	-	1,5x3, 6x3
	Green CZ	GCZ	0,8, 1,125, 1,5, 2, 3, 6	-	3x2	4x2	-	1,5x3, 4x2, 6x3
	Fancy Light Green CZ	FLG	0,8, 1,125, 1,5, 2, 2,5, 3, 6	2x2	3x2, 5x3	1,5x3, 4x2	-	1,5x3
	Marcasite	MKZT	1, 1,5, 2, 2,5, 3	2x2	-	-	-	1,5x3
	Fire Mystic Topaz	FMT	1,125, 1,5, 2, 3,	-	5x3	4x2, 6x3	-	1,5x3, 6x3







GEMCHART #4 FOR NOVIZIO FLATBACK STONES

SYNTHETIC OPALS

							
	Royal Blue	OP27	1,25, 15, 2, 25, 3, 4, 5, 6	2x2; 3x3	3x5; 4x6	2x4	-
	Sunrise Blue	OP26	1,25, 15, 2, 25, 3, 4, 5, 6	2x2; 3x3	3x5; 4x6	2x4; 3x6	-
	White Opal	OP17	1,25, 15, 2, 25, 3, 4, 5, 6	2x2; 3x3	2x3, 3x5; 4x6	2x4; 3x6	3x3, 4x4, 5x5
	Pink Opal	OP42	1,25, 2, 25, 3, 4, 6	-	-	2x4	4x4, 5x5
	Starry Night Opal	OP75	3, 4, 5, 6	-	3x5; 4x6	3x6	4x4, 5x5
	Night Indigo Opal	OP91	3, 4, 6	-	-	2x4	-
	Peacock Blue Opal	OP36	15, 2, 25, 3, 4, 5	-	3x5; 4x6	-	-
	Lavender Opal	OP38	15, 3	-	-	-	4x4, 5x5

GEMCHART #6

DRUZES

				
	Black Druze	BKDZ	4, 5, 6	3x5; 4x6
	Gold Druze	GDDZ	4, 5	3x5
	Grey Druze	GRDZ	4, 5	-
	Rose Gold Druze	RGDDZ	4, 5	3x5
	Blue Druze	BLDZ	5	3x5



OUR GEMS

Regular and flatback gem setting. The difference.

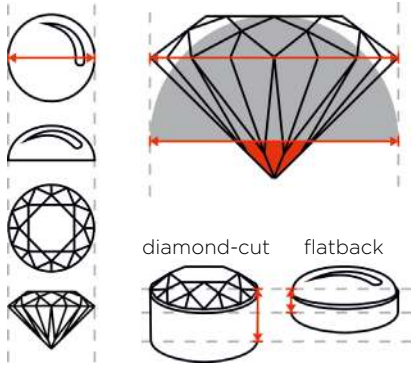

Diamond-cut gem is TALLER and can not be set into flatback setting.

- All gem sizes are listed in millimeters.
- All diamonds are at least VVS quality, and are cruelty-free. Mostly we mine them in Russia.
- All precious stones from **GEMCHART #1** are natural.
- All natural stones from **GEMCHART #2** are literally natural. And have a small surcharge per each gem.
- All opals from **GEMCHART #4** are synthetic.
- All synthetic faceted CZ **GEMCHART #3** are highest quality Cubic Zirconia on the market, originally from Austria.

FLATBACK SETTING GEM OPTIONS

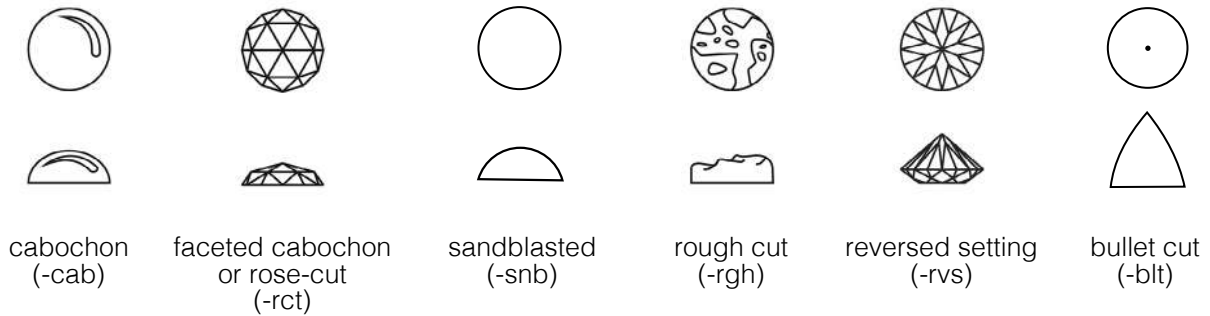

THOSE ARE NOT ALL OUR STONES - WE ARE HAPPY TO FIND SPECIAL GENUINE STONES UNDER YOUR DEMAND!
 JUST TELL US WHAT YOU'RE LOOKING FOR - EITHER IT IS CARNELIAN AGATE, CRYSTOPRASE OR ALEXANDRITE - WE WILL DO OUR BEST TO FIND IT AND MAKE JEWELRY OF YOUR DREAM WITH IT.
THE PRICE AND TIMING MAY VARY.



WARRANTY

We make our jewelry for people like us.

We pay money and we want our purchases to be worth of it.

So our warranty policy is To Be Fair.

All our jewelry items have lifetime warranty. This means if a gem falls off or changes color, we repair or replace the whole piece, if a clicker is too loose, doesn't click and hold tight, we change it.

If a threading or a pin gets broken because of a light attempt to put it into a stud, we change it.

Nevertheless, this is applicable only to manufacturing malfunction.

If you break a pin because of incorrect usage, if you squash a gemstone with force, if you heat it and it gets tarnish - these cases are supposed to be misuse and are not covered under the warranty.

If you get a problem with our jewelry, please contact the reseller who you bought it from. All jewelry gets inspected by reseller if it has traces of misuse.

If the reseller is sure that the damage was caused by manufacturing malfunction, he or she sends it back to manufacturer by a state post (with tracking number) and creates a replacement case via sending email to

sales@aurisjewellery.com

When we get a replacement request we send a new piece of jewelry (if available) with a state post or start manufacturing the same piece.

When the original jewelry comes back to us, we inspect it for misuse and if we find the misuse, we charge reseller for a broken item repairment and shipping costs.

Otherwise, we pay for shipping to reseller; reseller pays for shipping to client if needed.

WHOLESALE INFO

Auris Jewellery has been founded and proudly operates in Russia, St Petersburg area. We stay beside firsts who brought high-end piercing to Russia, first to establish market in whole continent, and we were first to show the world the forgotten quality and art of russian craftsmanship. Now we continue to rise the level of quality in piercing and traditional jewelry industry.

However, for your ease we have American brunch of our company, which may be easier to work with nowadays.

Our company values are Beauty, Trust and Honesty.

We have a core of our ideas - about this world, about how to work there, about how to make it a better place.

Thus, we divide people of this world into two groups.

There is a number of people who promote cheap asian replica jewelry like it is premium, while it is not.

There are people who sell Auris generic jewelry replicas and publically use other «brand» name.



There are people who sell chinese replicas of respectable Titanium brands like it is the best on the market.

Whether they understand that or not, we do not want our business and our jewelry to be around those people.

Work honest or work elsewhere.

Our sales policy is that in 2021 we stop selling our jewelry to shops who sell brands who copies our jewelry, and we downscale priority of orders of people who promote chinese companies brands with no ideology and no future.

We live in Auris World. Hopefully, you too.

Nevertheless, if it happened that you are on the other side by mistake, we do have Novizio brand. It is limited line of jewelry, but every piercing studio can order it to replace replica jewelry in stock.

WHOLESALE F.A.Q.

- What's your manufacturing time? - For orders below AUR 10.000 it is between 3 and 6 weeks normally, except periods 2-3 months upfront big conferences and tradeshows. For Novizio-only orders manufacturing is 2-3 weeks only!

- How long is it to ship to other countries? - When shipping from Russia, we use Russian courier service. It normally takes 2-4 weeks to pass the border. If you buy jewelry from our American stock, shipping with UPS or FedEx is 1-5 business days for domestic shipping or 1-2 weeks for international.

- How much does shipping cost? - we charge AUR 50 to ship from Russia.

- Do you have warranty? - Yes, you are all covered. Our gemstones don't turn its color (unless you haven't been clearly notified it does), our gold is safe and don't cause allergies. Our pins are steel and secure if you use our bending tool properly. Our threads are gold and don't fall off. Warranty against manufacturing defects is lifetime. We make proudful jewelry!

- Is there a minimal order? - Yes. **It is AUR 500** , this makes it worth of paying for shipping.

- What is AUR? - AUR is Auris Unified Rouble. It is our internal currency used to control our national currency strength against world major currencies. We have a conversion rate with EUR, USD, RUB and other currencies. This conversion may change over time due to political and economic situation changes. This is minimal reasonable amount to have good enough selection representing our brand. For returning clients minimal amount is AUR 500 - just to make it worth of shipping.

- Can I buy something right now? I don't want to wait! - Normally we do have wholesale jewelry stock for sell at our website: **wholesale.aurisjewellery.com**. Contact our sales manager to get help with opening your wholesale account if you don't have it yet!

- Do you sell for retail clients? - Yes, we do. We maintain our presence online and offline, always working on building our brand reputation. Because luxury things were never born in wholesale. However we respect our resellers business and take as much precautions as we can not to intervene with our resellers.

- Can I open an account with you in a town, when there is already Auris reseller? - It depends on the town size and the opinion of that reseller. We advice with our loyal clients before opening a door to their competitors.



AURIS BRANDED DISPLAY

We work in jewellery sells for long time, and know how important are demonstration tools. Specially for our jewelry and for body piercers we designed our displays. Just take a sight how much better gold looks on it!

Advantages of our displays are:

1. The angle is regulated from 0 to 90 degrees. Yes, literally you can put it on any kind of display case shelf!
2. For making it 0 to 90, you have to reverse the display. To make it working, we invented detachable logo plate, so you can rever it and logo will still look correctly.
3. Detachable logo has a lot of advantages - you can move it from display to display, depends on your goal. You don't need every display with a logo plate, and you can buy as many you need, they are sold separately.
4. For tops displays, logo plate mounts right in jewelry slots! Take it away and put two more pieces on your display; sell them and return logo back!
5. For rings displays, logo plate mounts into two 24g holes. You can take it away and put two threadless tops in!
6. Our tops displays have one hole size for each thread - 14g (1.2mm hole), 18/16g (1mm hole), threadless (0.5mm hole). You can put 16g top onto 14g display, it will stay there but it won't hold securely.
7. And overall, you can make beautiful compositions of.

Displays which will help you to show our jewelry at its best!

You can put a detachable logo plate or logo badge in two holes in the middle of the display, giving your selection a brand name.

The holes are 24G, so you can put two threadless tops instead of logo plate.

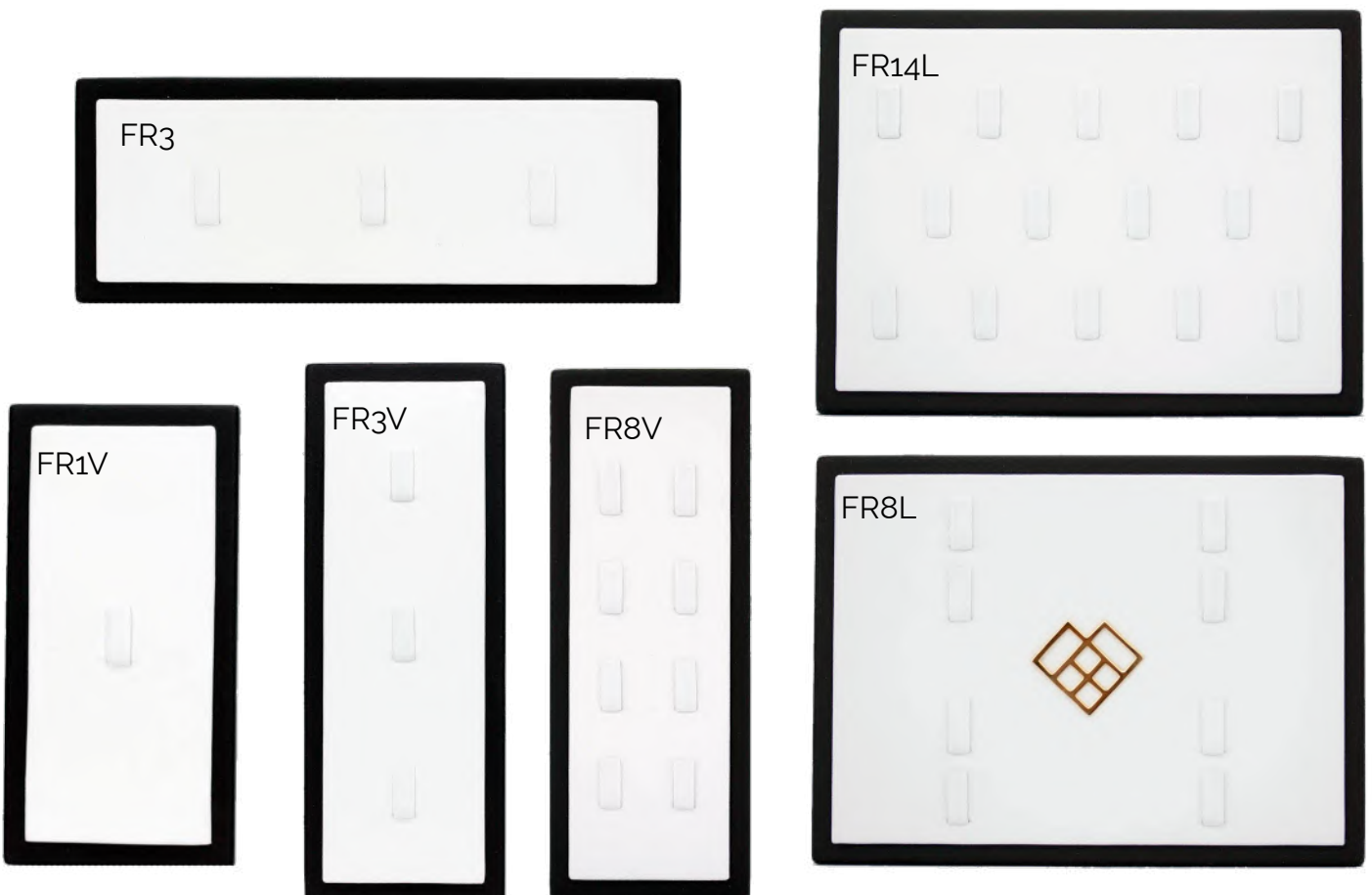

Ear display right

Ear display left



H12



H17



H15



H12L



H22

SR3V



H8



H6

SR1

H1





Spacer podium big



Spacer podium medium



Spacer small

On these spacers you may print out your own image and insert into vertical wall, where the logo is printed!



Stand for 5 or 3 displays, and you can combine different options.

EHD5



EHD3





NEW JEWELRY AND BRAND NEWS