













-  x3
-  x4
-  x14
-  x2
-  x21
-  x2
-  x1
-  x2

1

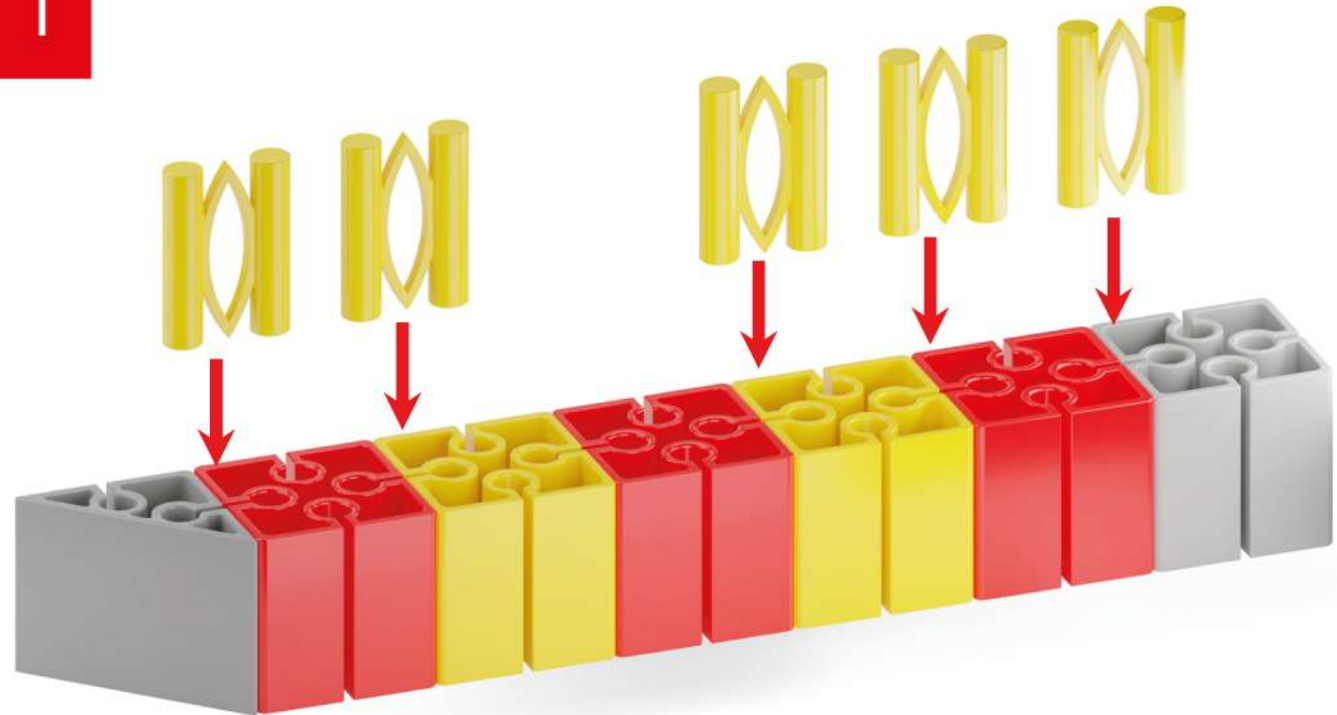

-  x6
-  x5
-  x5

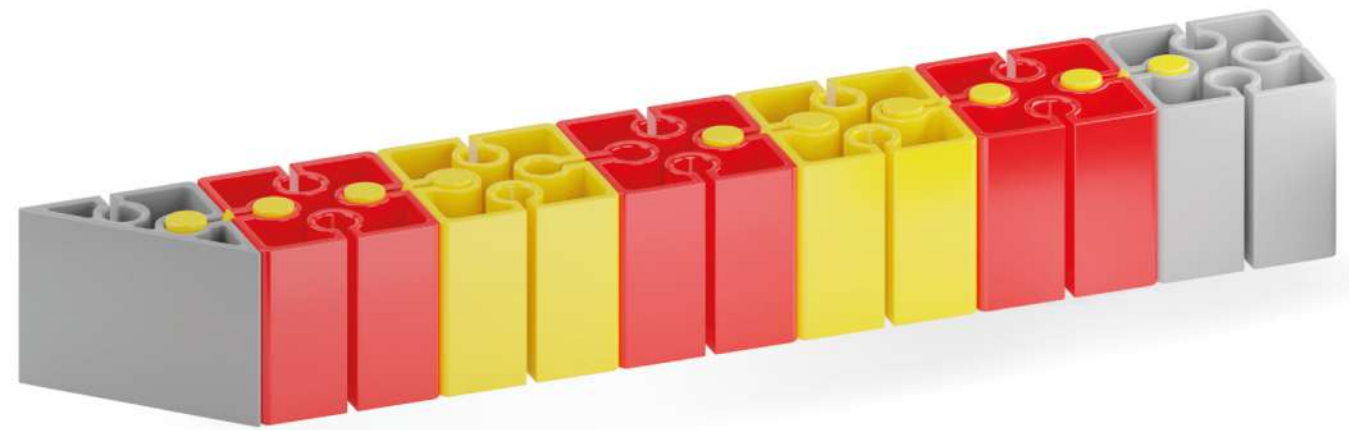

2

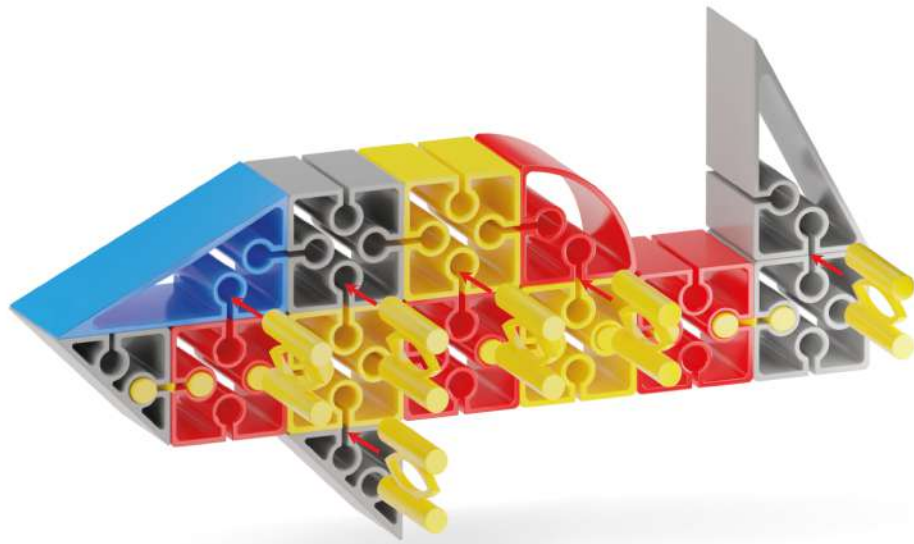

	x2
	x8
	x2
	x1

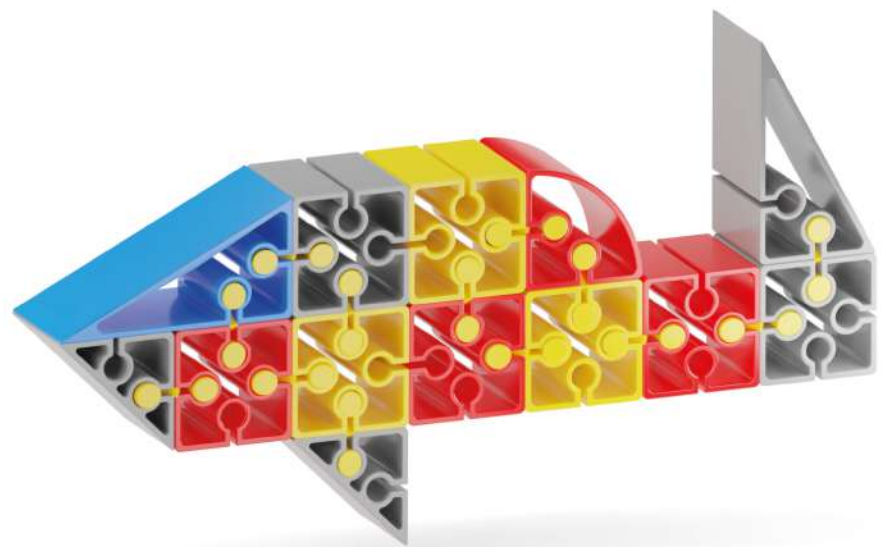
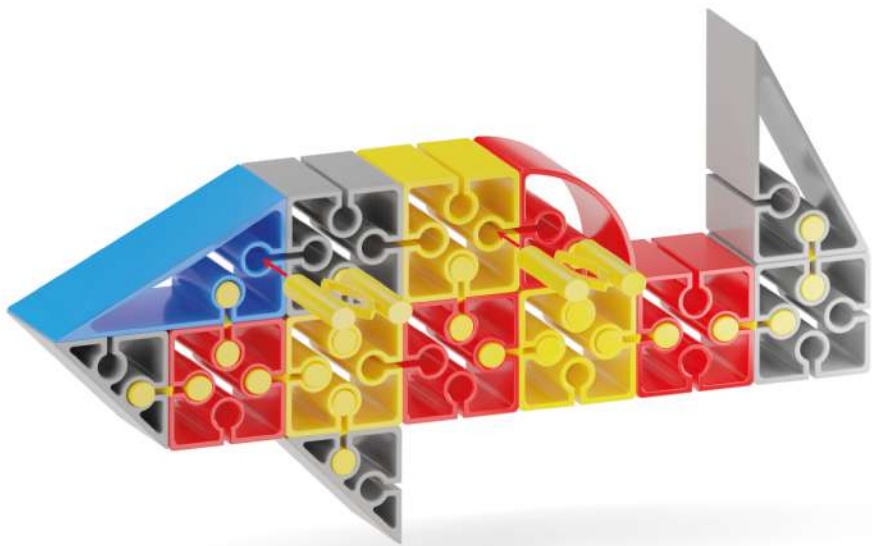

3

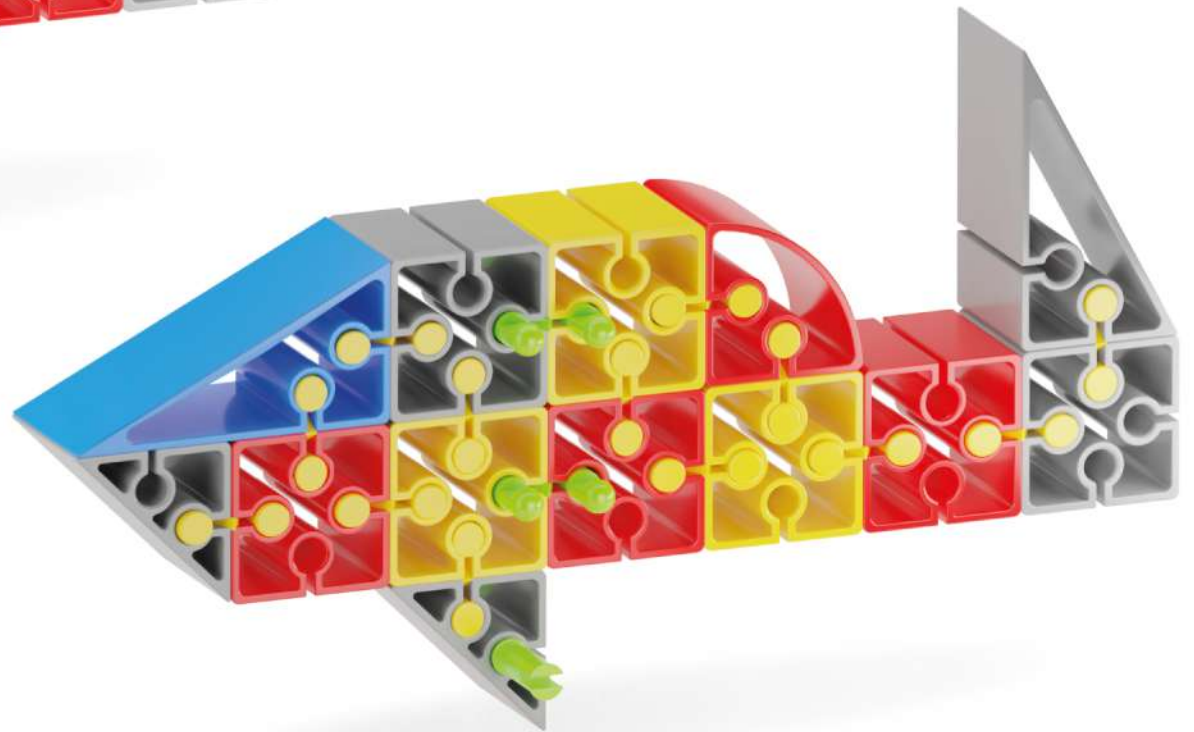
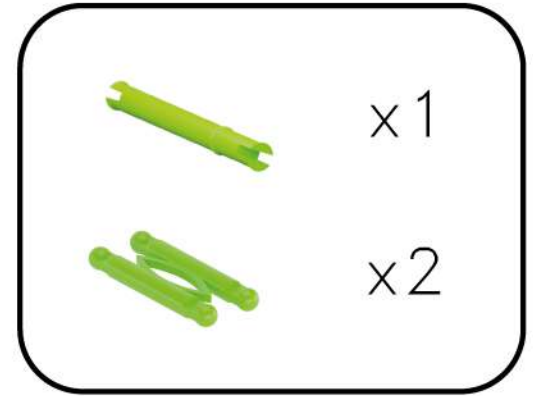
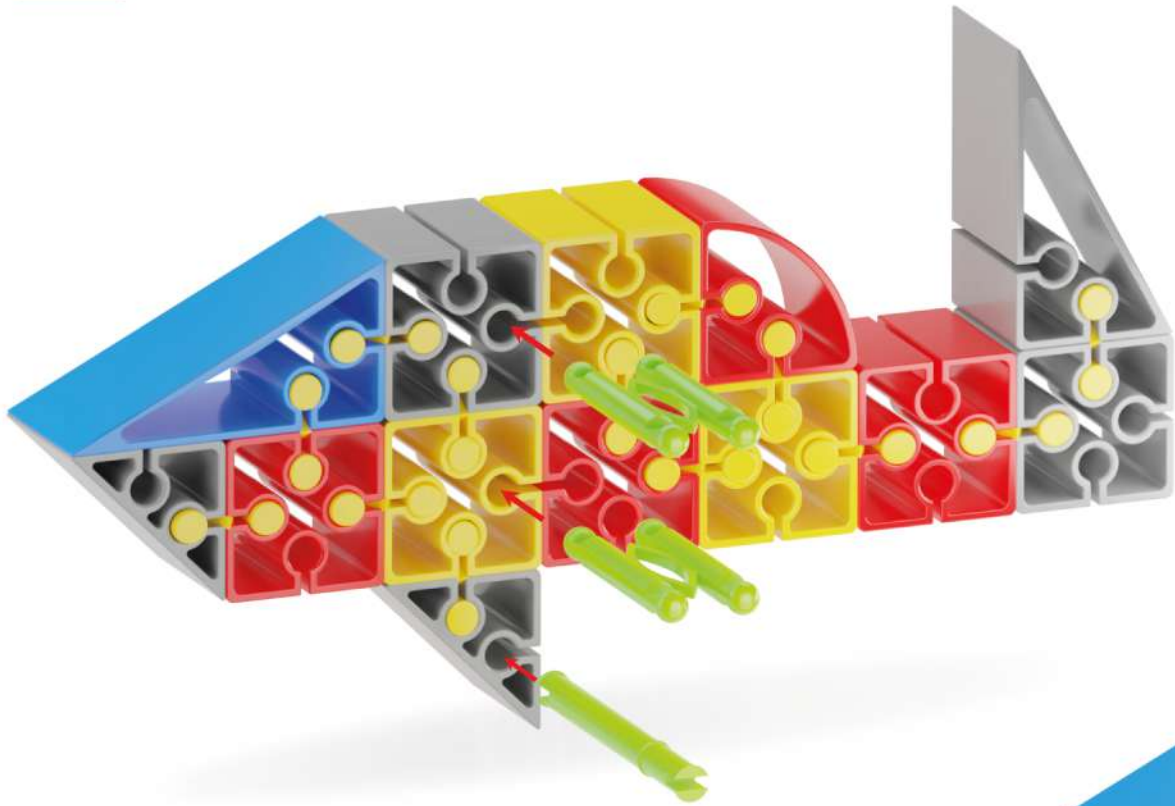

4

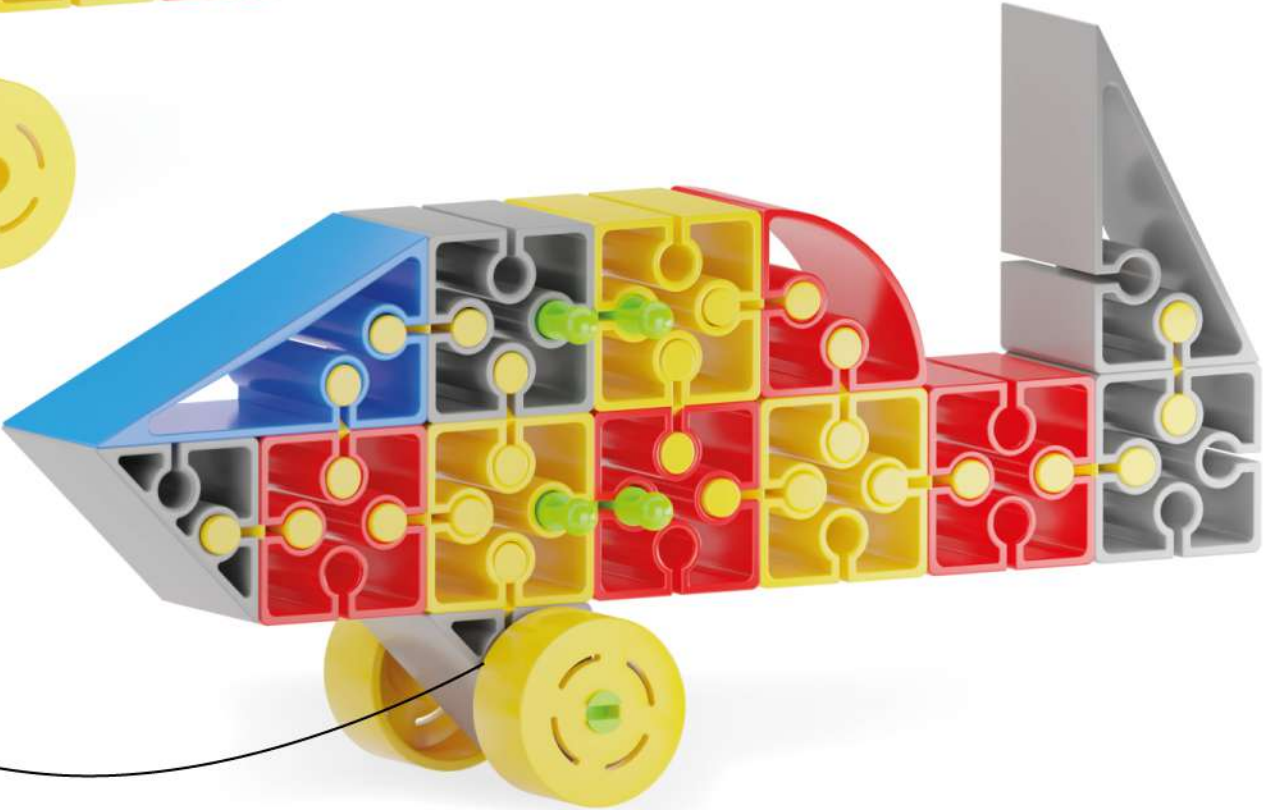
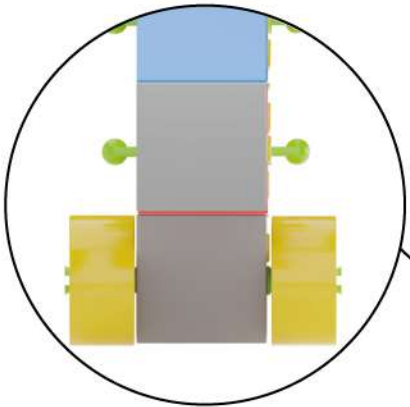
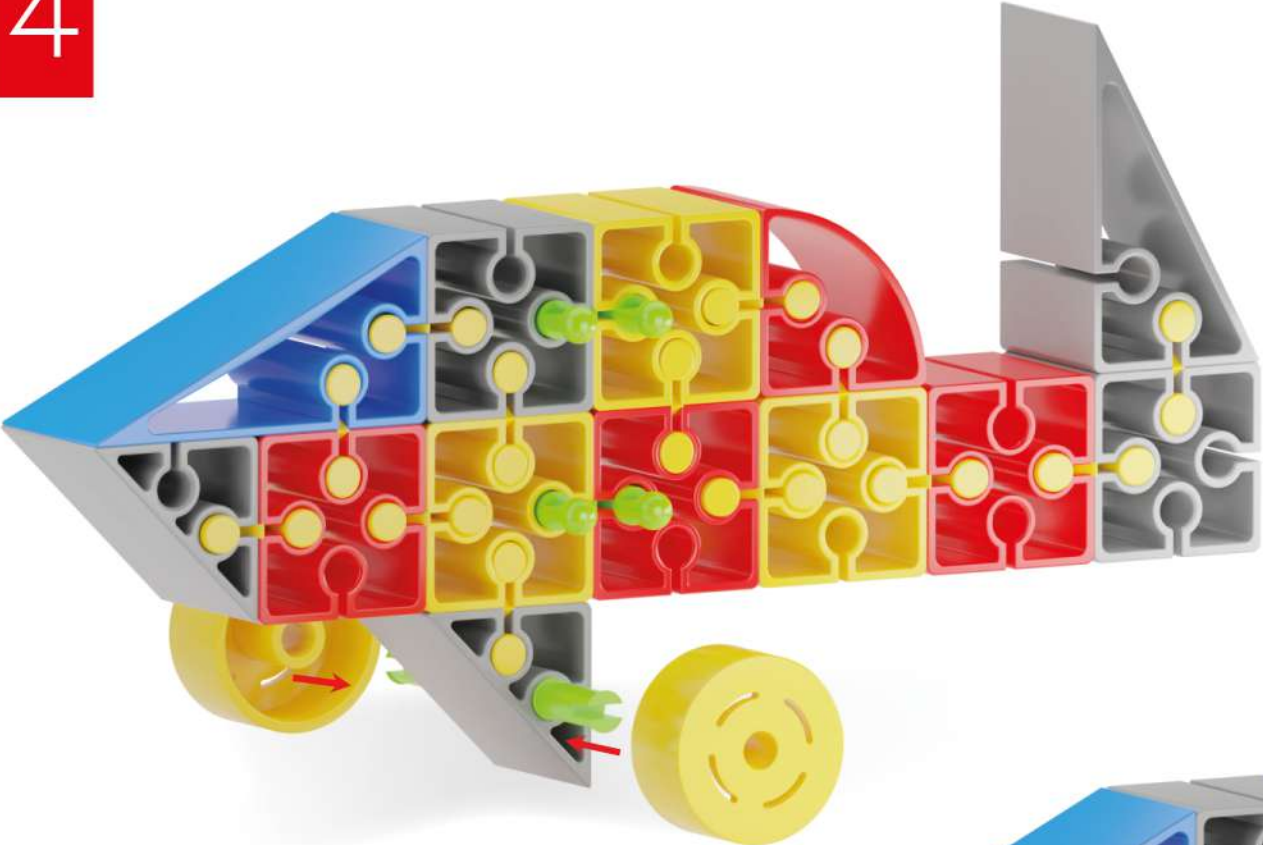

5

x2

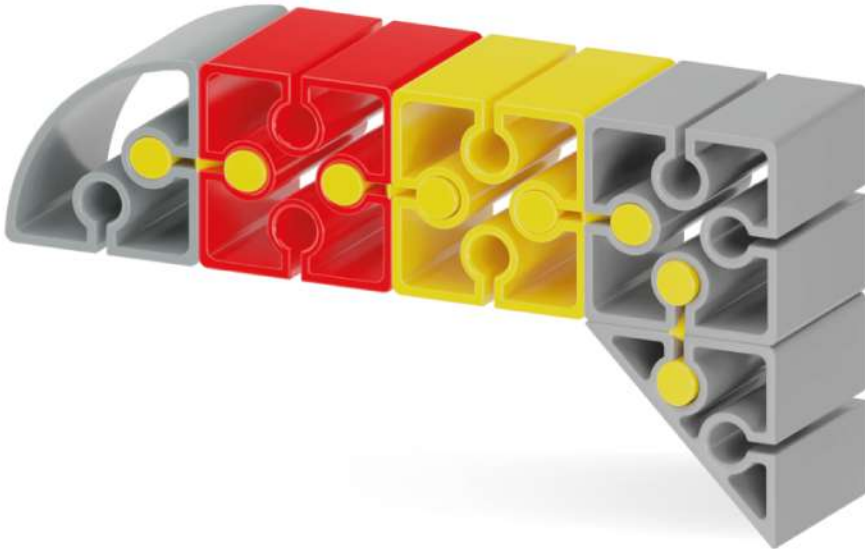
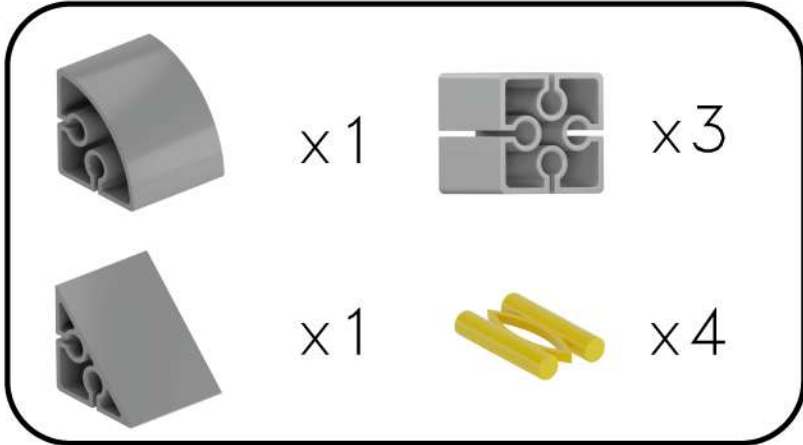
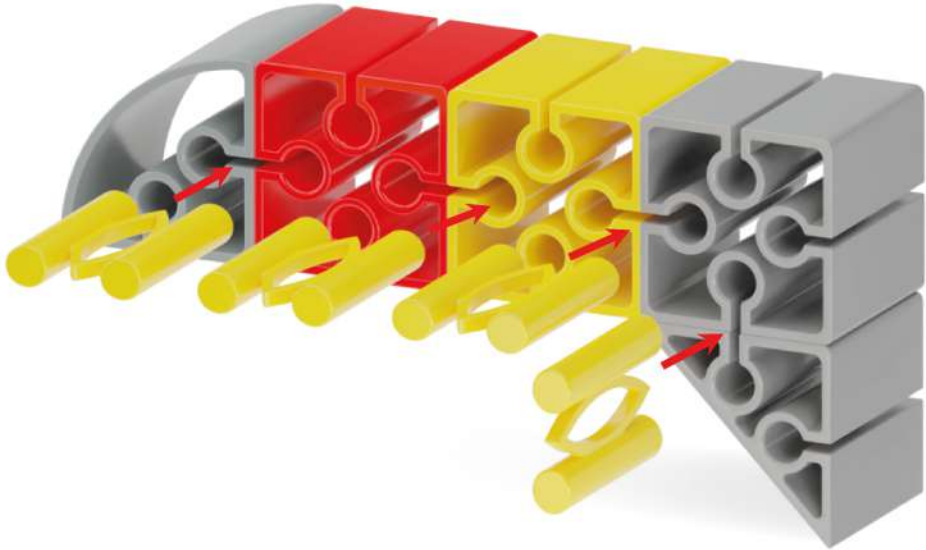

6

