

1

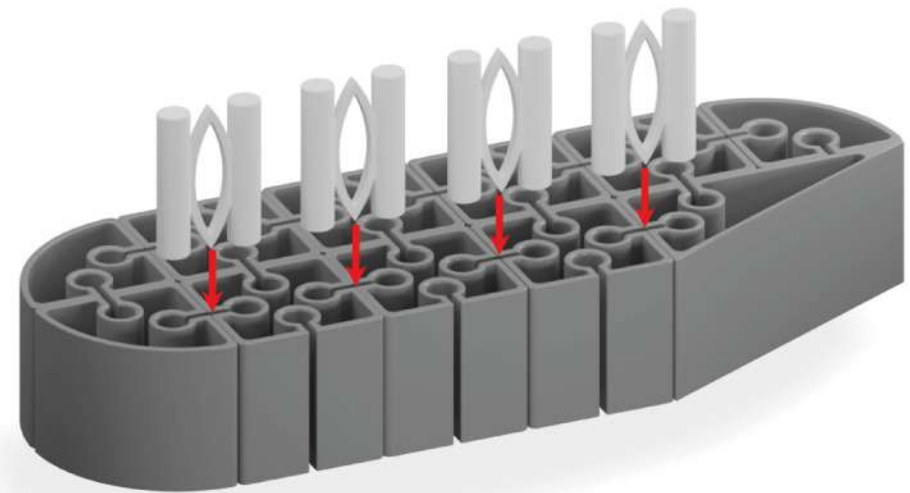

x2

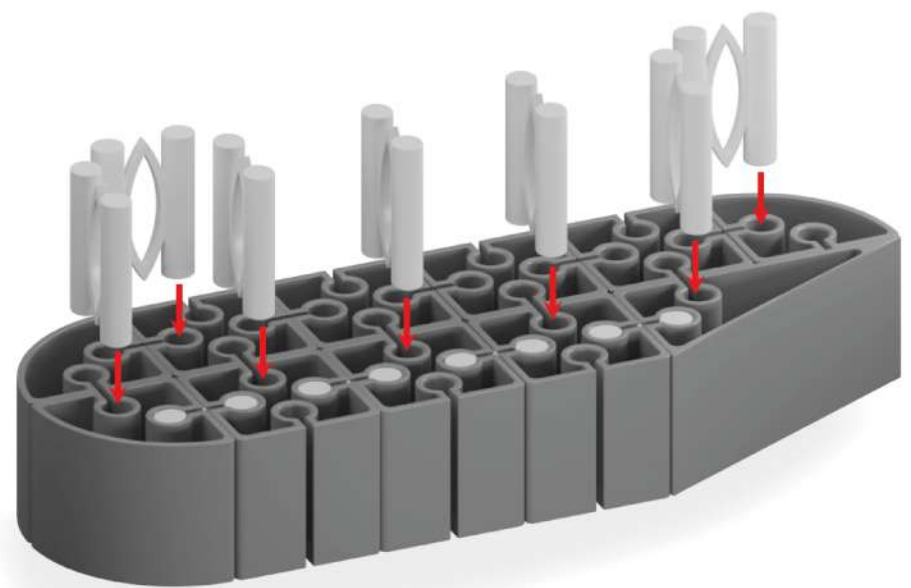
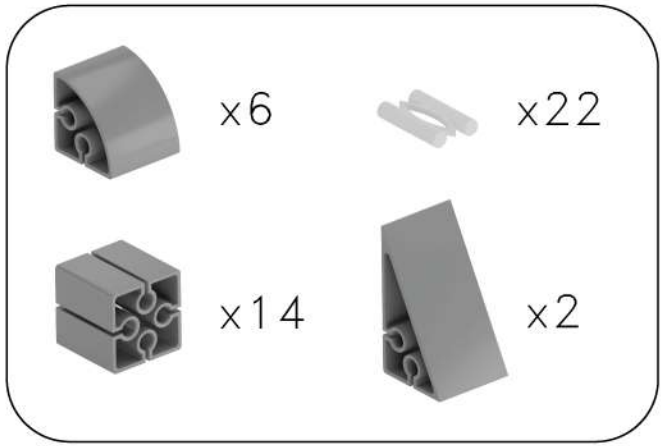

2

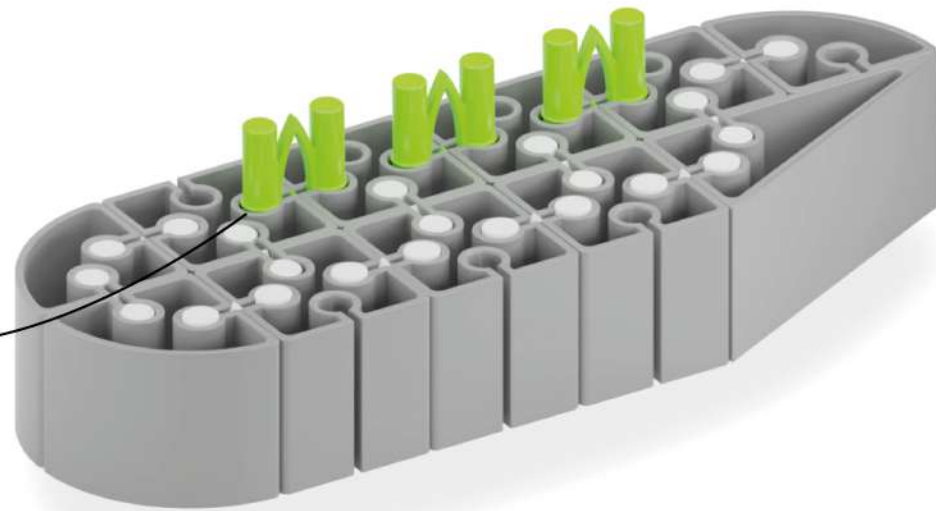
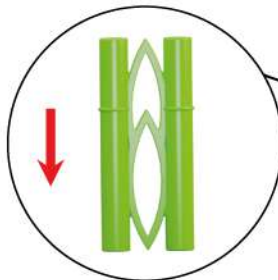
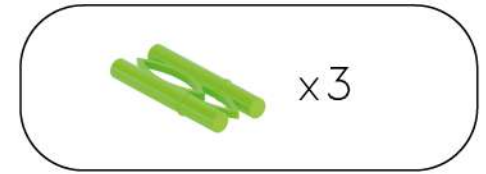
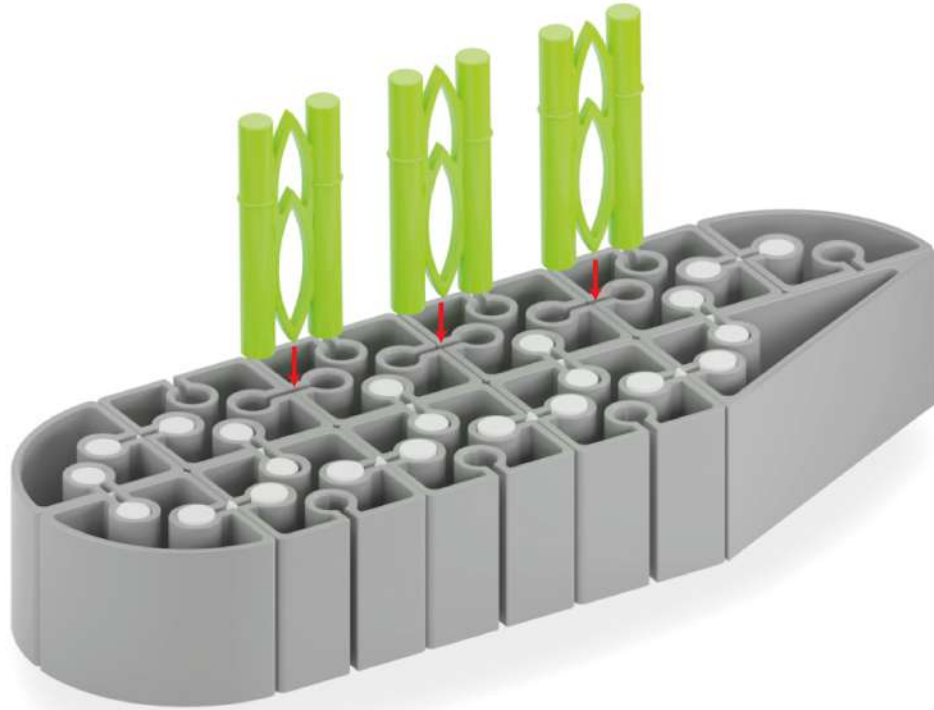

3

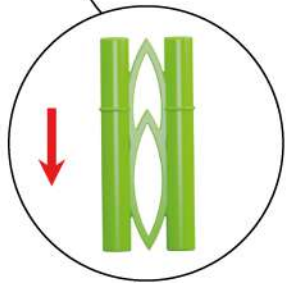
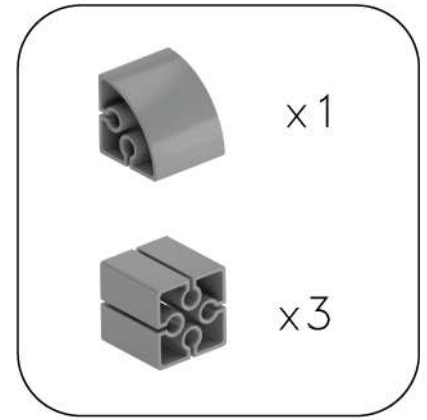
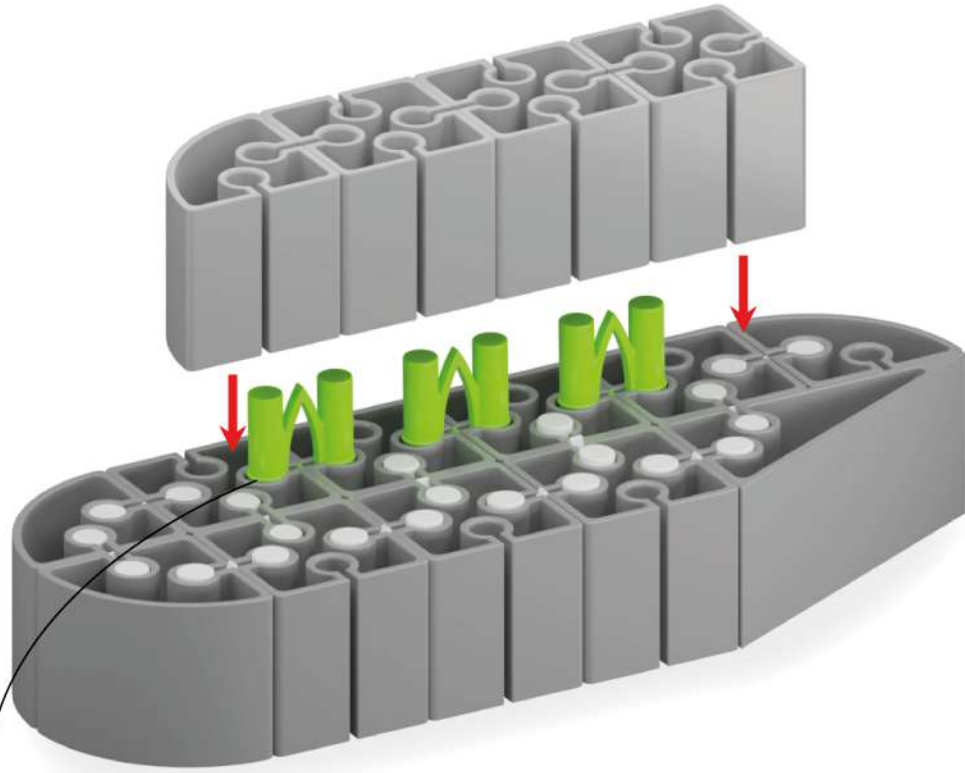

4

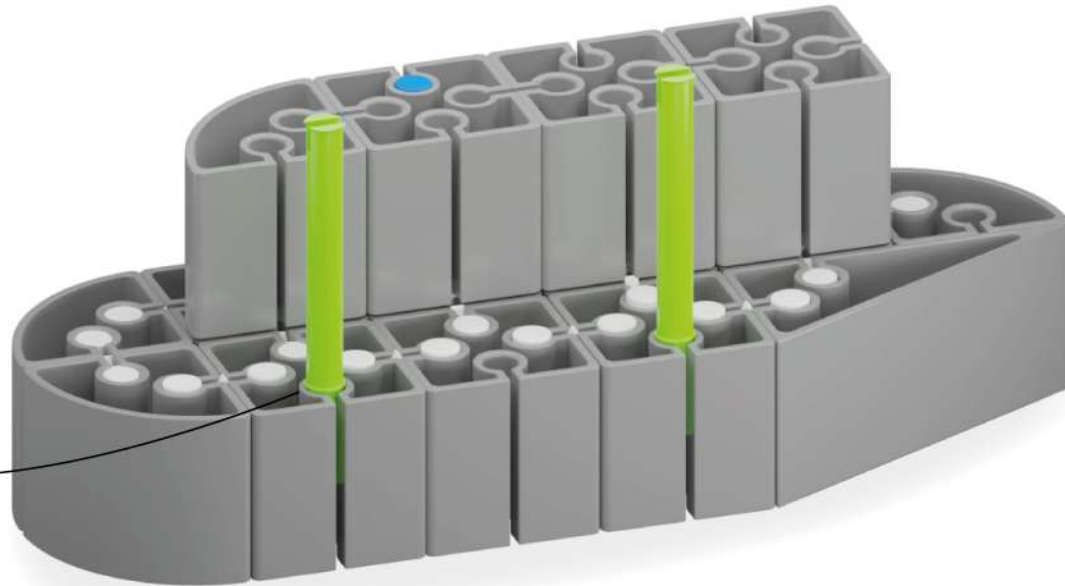
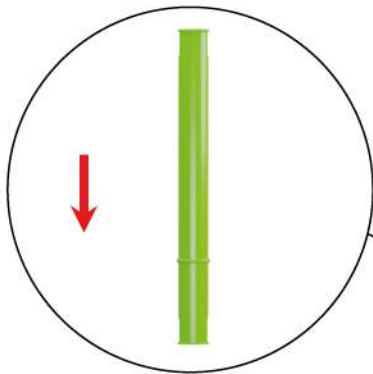
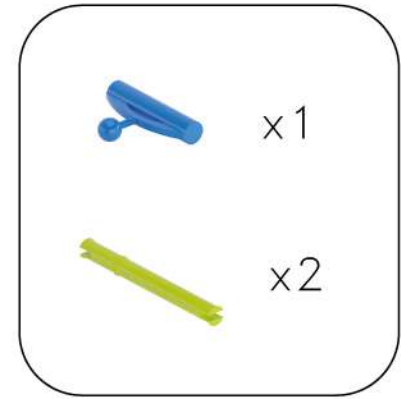

5

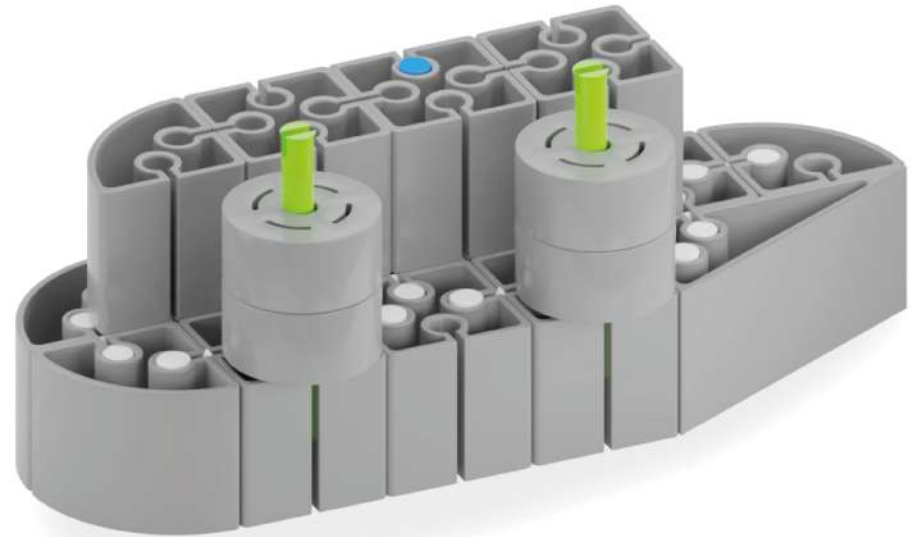
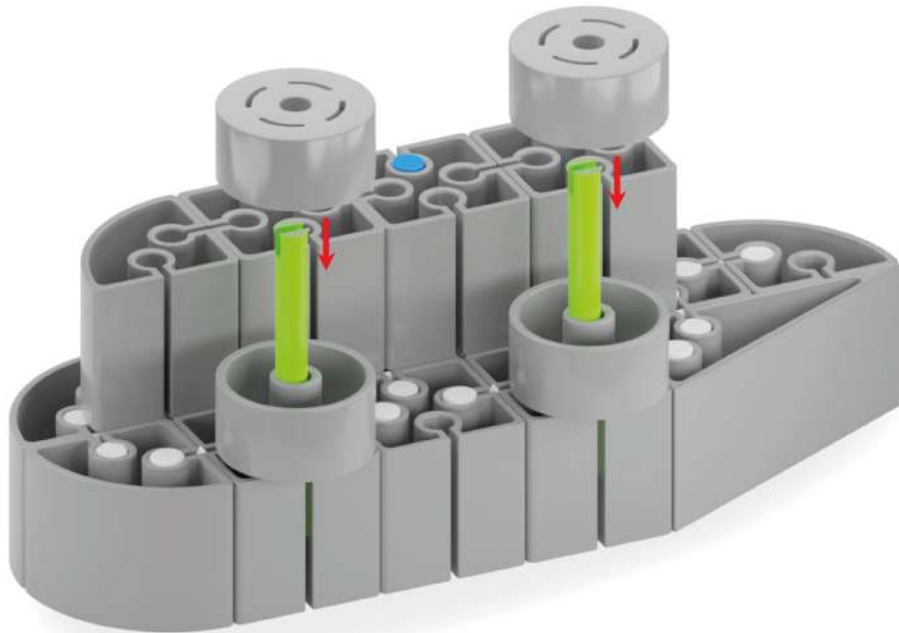
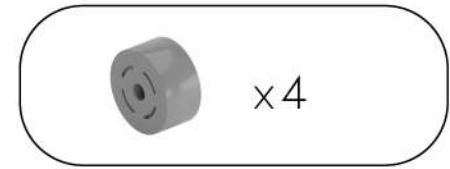
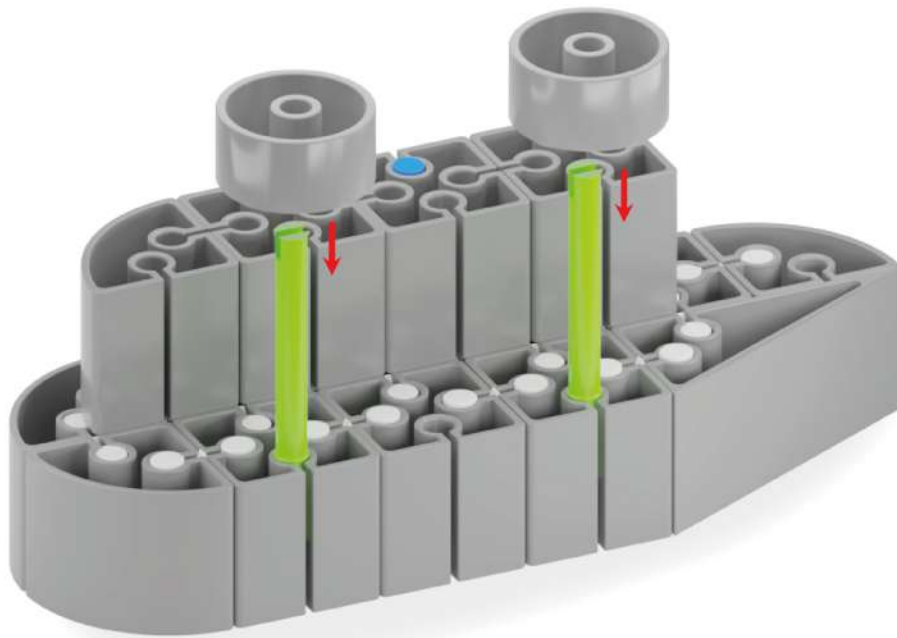





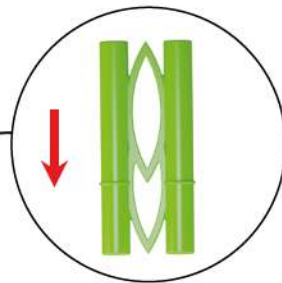
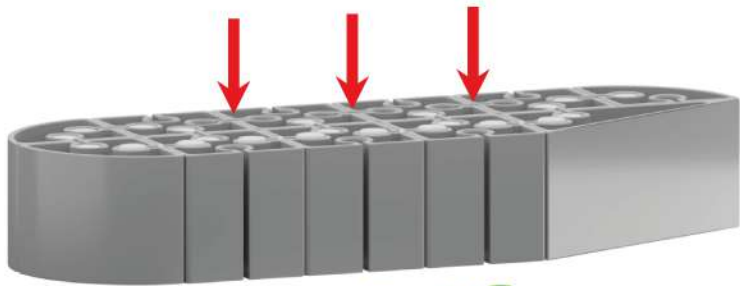
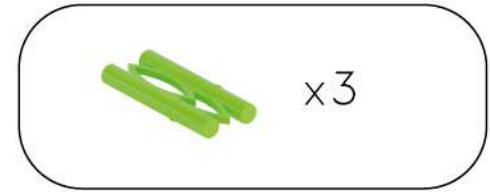
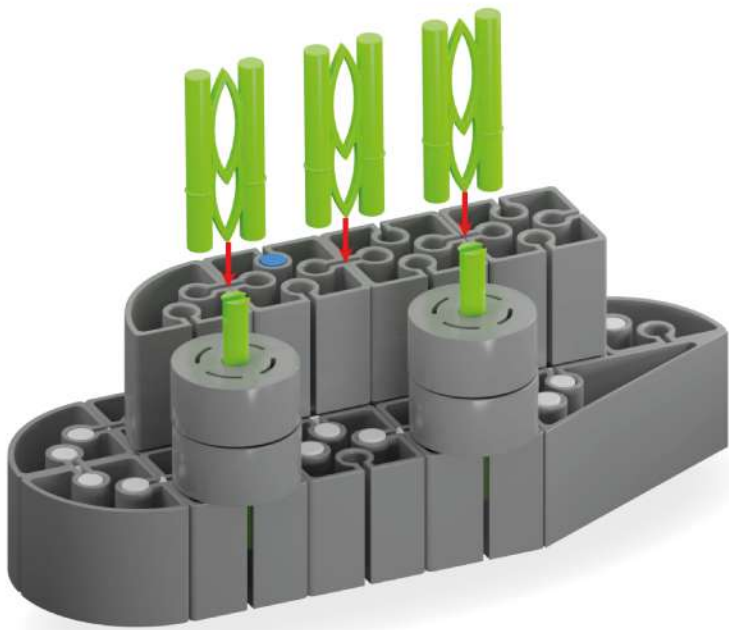

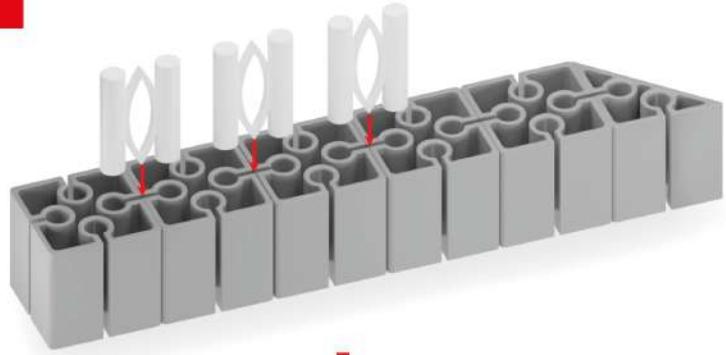

6



7



-  x2
-  x7
-  x4
-  x3
-  x3

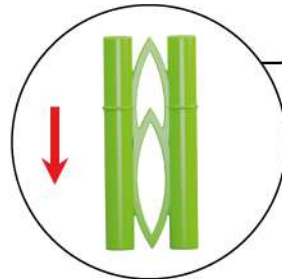
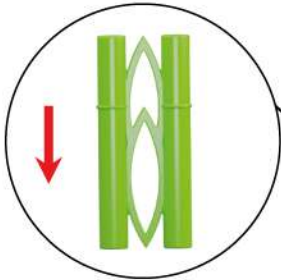
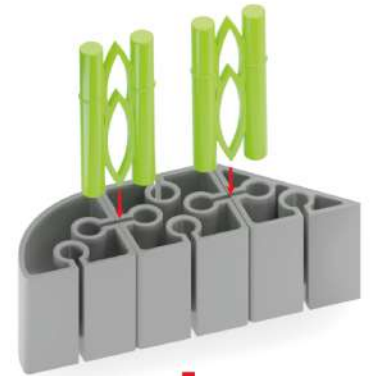
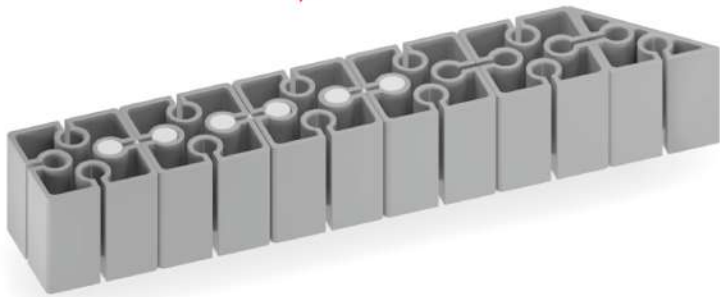



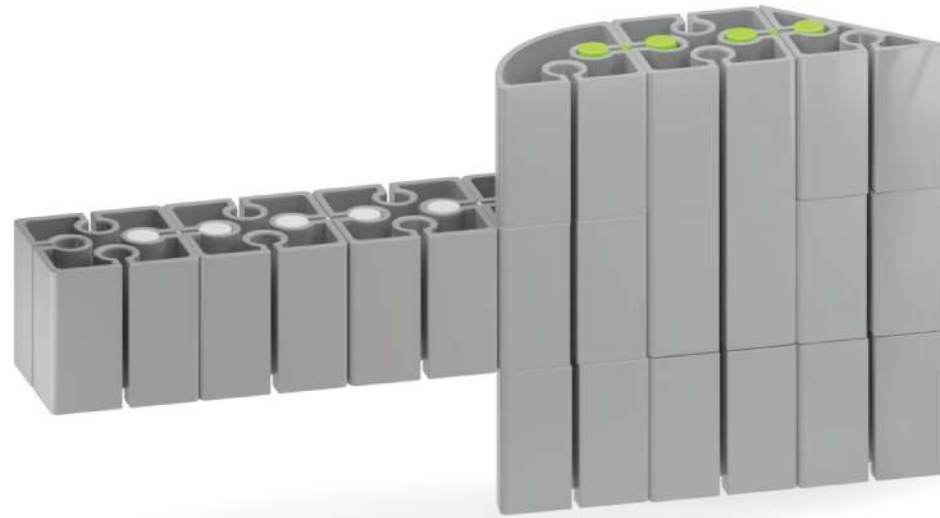
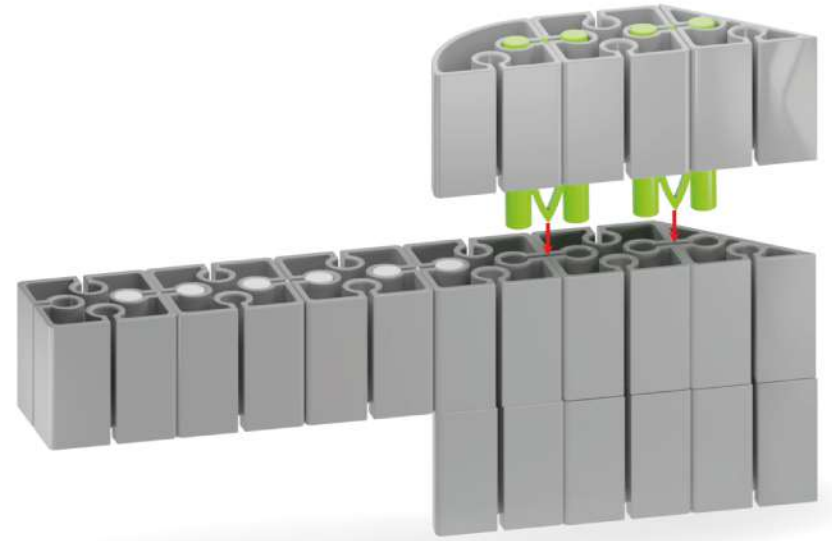
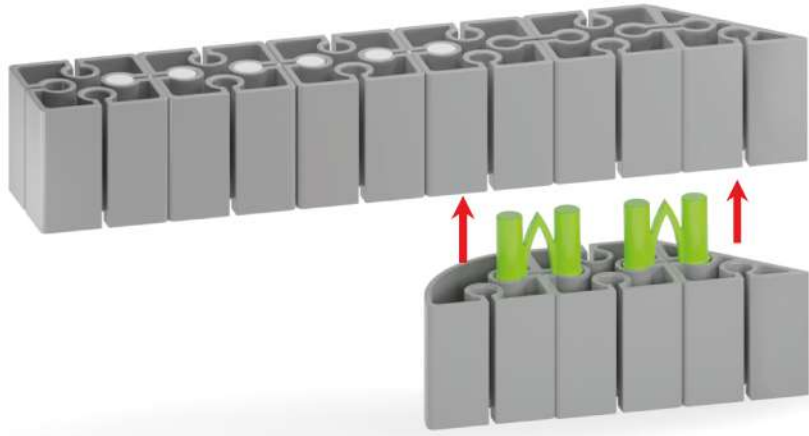

9

