



**Attention**  
Risk of Danger,  
Warning



**High Voltage,**  
Risk of  
Electric Shock



**Double / Reinforced**  
Insulation



**NOT**  
Litter



**CE Mark**

## TECHNICAL SPECIFICATION



- **Dimensions** : 48x48mm
- **Panel Cut-out** : 45,5x45,5mm
- **Display** : 2x4 Digits 7 Segment
- **Count Input** : 2 x (Max:7500 Hz, 5-30V)
- **Reset Input** : 10ms (min), Positive input (PNP only) (5..30V)
- **Output** : Out; Relay (O-NO-NC), 250VAC, 2A, Resistive load  
open collector (NPN), 30V, 100mA max.



- **Sensor types** : PNP/NPN proximity switch - NPN/PNP/Totem-pole output encoder
- **Input frequency** : 20, 500, 2500, 7500Hz selectable
- **NPN Selection** : Connect "npn select" to "+12V" to select NPN sensor for CP1 and CP2.  
Reset input is always PNP. For totem pole or PNP type sensor "npn select"  
left unconnected.



- **Sensor Supply Out** : 12VDC, 50mA max. (unregulated)
- **Supply Voltage** : 100..240VAC, 50-60Hz or 24Vac/dc (optional)



- **Power Consumption** : < 6VA
- **Humidity** : 80% up to 30°C, then linearly decreases to 50% at 50°C (non-condensing)
- **Altitude** : < 2000 m
- **EMC** : EN 61000-6-1, EN 61000-6-3 (Only light industrial environment)
- **Safety** : EN 61010-1; Pollution degree 1, measurement category I, (Only light industrial  
environment, double/reinforced isolated, non-conductive pollution environment)



- **Protection Class** : IP20; according to EN 60529
- **Storage Temperature** : -10°C .. 60°C (no icing)
- **Operation Temp.** : 0 .. 50 °C



- **Weight** : < 0.5 kg
- **Key** : Micro switch
- **Torque for screwing** : Max. 0.5 N.m

**GENO**  
Preset Up/Down Counter  
DS204-230VAC  
www.gemo.com.tr

100 ... 240VAC  
50/60Hz 6VA

1 8 - npn select

2 9 - +12V 50mA

no 3 10 - CP 1 Input

Out 4 11 - CP 2 Input

nc 5 12 - Reset In

Out: 250VAC max.2A  
resistive load

13 - SS Out

14 - GND

**no:** normally open  
**nc:** normally closed

Gürbüzöğlü Elektronik San. ve Tic. Ltd. Şti.  
Çamlıtepe Cad. No:297 / 3-4 Siteler, Ankara, Türkiye  
Tel: +90-312-3503900, Fax: +90-312-3511117

(\*) Connect  
SS Out return  
pin directly to  
GNG

(\*\*) Use free-  
wheeling diode to  
protect SS Out

(\*\*\*) To select NPN option;  
connect "npn select" to  
"+12V".

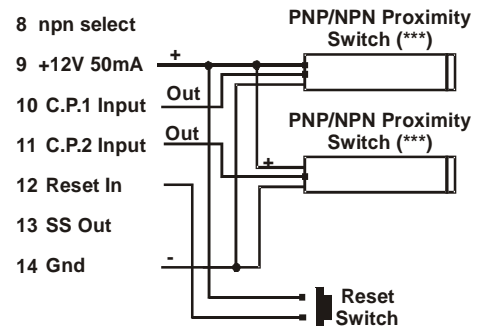
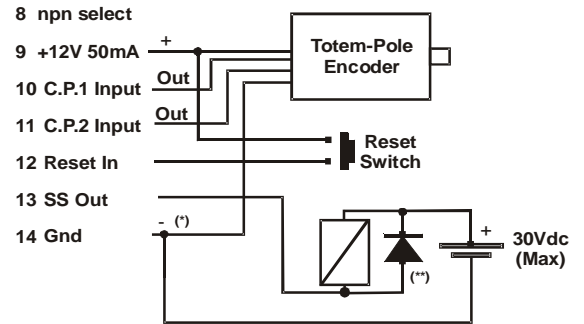
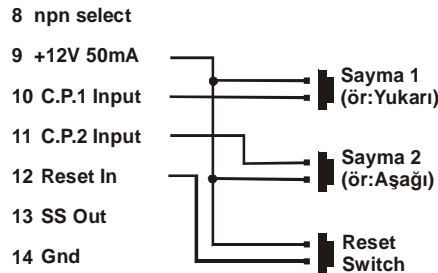

























http://www.gemo.com.tr  
e-posta: info@gemo.com.tr

---

**INSTALLATION, USE and WARNINGS**

---

-  ● This device and its packing is NOT litter and may NOT be disposed of with domestic waste. Please return this device and its packing to an appropriate recycling point at the end of its service life.
-  ● Please read this user manual carefully and completely before installation and use. Please take into consideration all warnings mentioned in this manual.
-  ● DS204 is suitable only for permanent panel type mounting
-  ● Installation and use of this device must be done by qualified, authorized and trained technical personnel only.
-  ● Inspect device carefully before installation. Do not install and use broken and defective devices.
-  ● Do not disassemble device. Do not make any repair on any part of the device. There is no accessible part inside the device. Please contact to manufacturer for broken and defective devices.
-  ● Do not use device in environments subject to flammable, explosive and corrosive gases and/or substances.
-  ● This device is designed for applications only in light industrial environments. This device is not suitable for medical and residential use. This device is not suitable for use related with human health and safety. This device is not suitable for automotive, military and marine use.
-  ● Do not allow children and unauthorized people to use this device.
-  ● Before installation and any technical work, disconnect the power supply and mains connections.
-  ● Check the power supply voltage level before power on, and make sure voltage level is in specified limits. Check quality of neutral line. Improper neutral line may give permanent damage to the device.
-  ● Connect an external power switch and an external fuse (1A, 250VAC) to the power supply line that are easily accessible for rapid intervention. Connect an external fuse (2A, 250VAC) for each relay output separately.
-  ● Use appropriate cables for power supply and mains connections. Apply safety regulations during installation.
-  ● Install the device in a well ventilated place. Install the device permanently into a proper panel cut-out. Fix the device with two fasteners supplied with the device. Only front panel must be accessible after installation is completed.
-  ● Do not operate the device other then the environmental conditions given in Technical Specification.
-  ● Do not operate the device in environments that may cause conductive pollution.
-  ● Take precautions against negative environmental conditions like humidity, vibration, pollution and high/low temperature during installation.
-  ● Keep device, signal cables and communication cables away from circuit breakers, power cables and devices/cables emitting electrical noise. Use shielded and twisted signal and communication cables and connect shield to earth ground on device side. Keep length of signal and communication cables less than 3m.
-  ● Prefer to use (Inpt=Phs1) option for encoders, select (Freq=20) to count mechanical switch ON-OFF pulses, select the minimum input frequency option that suits your application.
-  ● For Inpt=1u2u, 1u2d, Phs2; input signal frequency shall be at most 1/2 of the selected input frequency option if both inputs are used. And for Inpt=Phs4; input signal frequency shall be at most 1/4 of the selected input frequency option if both inputs are used.
-  ● In your applications, always use separate and independent mechanical and/or electromechanical devices/apparatus to support DS204 to handle emergency cases..
-  ● Use insulated cable end-sleeves at the end of cables screwed to the device connector terminals.
-  ● Maximum torque for screwing; 0.5 N.m.
-  ● Please check [www.gemo.com.tr](http://www.gemo.com.tr) for latest device and documentation updates regularly. All updates and all information are subject to change without notice.

---

**GENERAL SPECIFICATION**

---

- This device is designed for basic control applications only in light industrial environments.
- 2x4 Digit Display, single PRESET, single OUT, up/down counter
- Counts switch, proximity switch & incremental encoder input
- Password protection, Selectable input frequency, Calibration constant; 0.001 ... 9.999
- Selectable decimal point; 1. ... 3. Digit, 7 input / 9 output function options, Adds "OFFSET" to Count Value
- OUT; latch or 0.1..999.9 seconds pulse
- Loads Count value & OUT status at the latest power failure after the first power on
- RESET via front panel
- EEPROM memory to store settings
- Dimension: 48x48mm, Easy connection with plug-in connectors

**FRONT PANEL RESET**

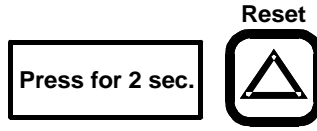

**PROGRAMMING PRESET VALUE**

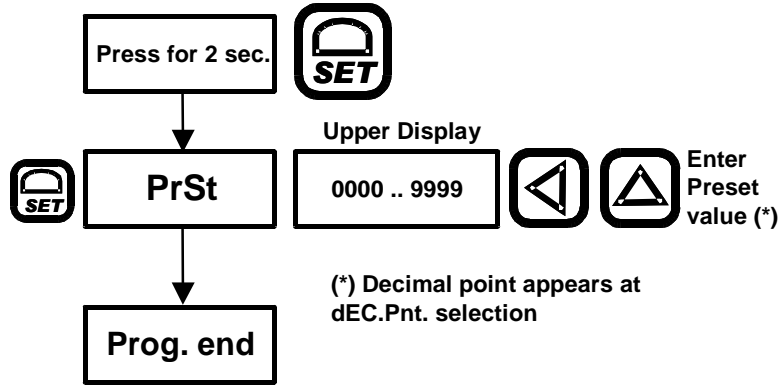

**INPUT TYPES**

Cr.dr = oppo								
	Cr.dr = drct							
		Inp = 1u 2h	Inp = 1u 2u	Inp = 1u 2G	Inp = 1u 2d	Inp = P h s 4	Inp = P h s 1	Inp = P h s 2

NPN OFF

NPN ON

PNP / Totem Pole ON

PNP / Totem Pole OFF

**CLAENING**



Do not use any solvents (alcohol, thinners, benzine, acid, etc.) or corrosive substances to clean the device. Use only a dry and clean non-abrasive cloth. Before cleaning, disconnect the power supply and mains connections.

**PROGRAMMING PARAMETERS**

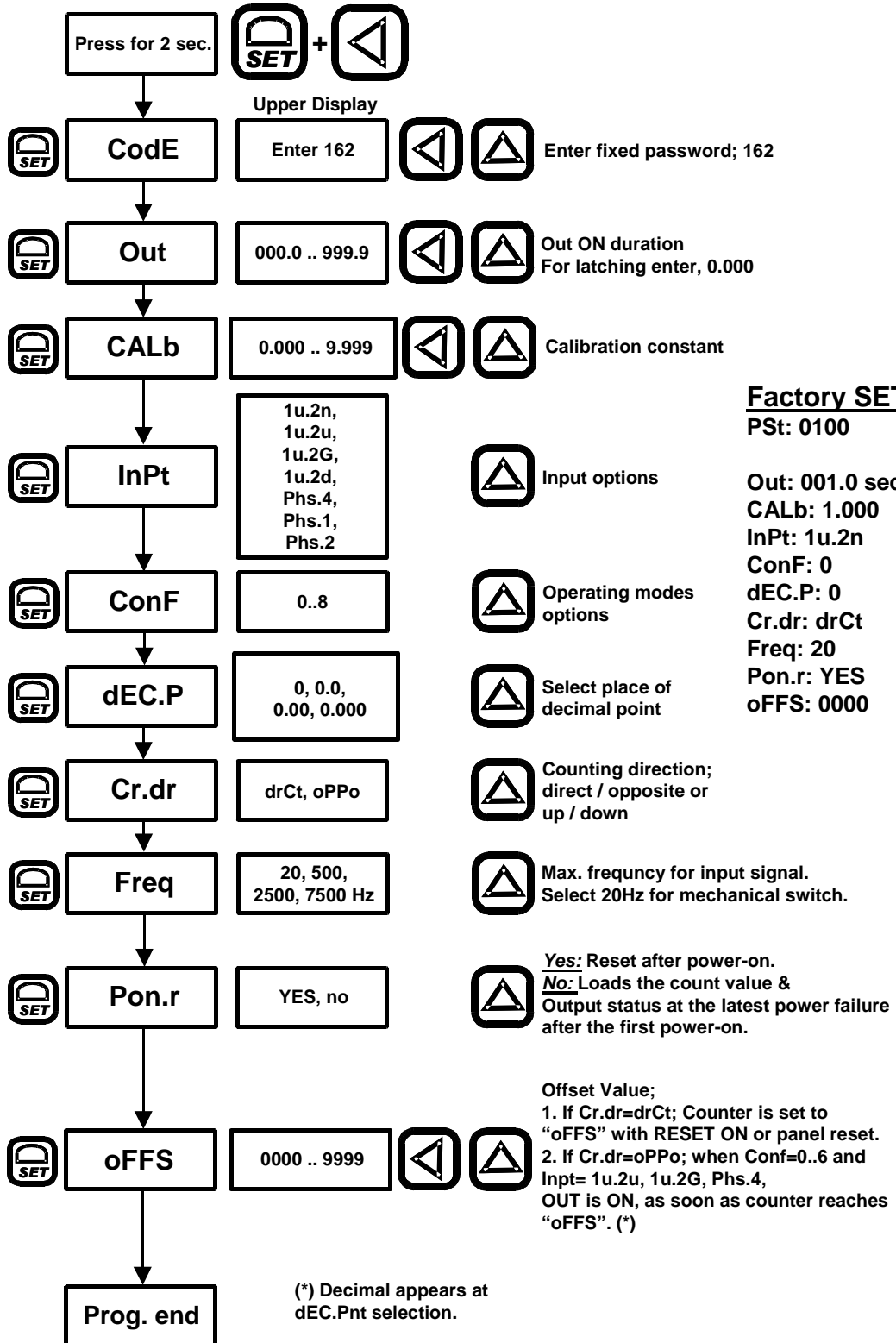

**Factory SET Values:**

PSt: 0100  
Out: 001.0 sec.  
CALb: 1.000  
InPt: 1u.2n  
ConF: 0  
dEC.P: 0  
Cr.dr: drCt  
Freq: 20  
Pon.r: YES  
oFFS: 0000

**Note:** If no entry is done for 20 sec. during programming, current entries are accepted and saved to EEPROM memory.

## OPERATING MODES

	Inpt = 1u2u, 1u2G, Phs4 Cr.dr = drct	Inpt = 1u2u, 1u2G, Phs4 Cr.dr = oppo	Inpt = 1u2n, 1u2d, Phs1, Phs2	Comment
Conf 0				Counting continues up/down until RESET ON after Preset is reached.
Conf 1				Counting stops until RESET ON after Preset is reached.
Conf 2				Counting continues up/down until RESET ON after Preset is reached.
Conf 3				Counter is reset after Preset is reached.
Conf 4				Counting continues up/down after Preset is reached. Counter is reset with OUT pulse OFF.
Conf 5				Counting stops after Preset is reached. Counter is reset OUT pulse OFF.
Conf 6				Counter is reset after Preset is reached but display freezes until the end of OUT pulse.
Conf 7				OUT is ON when counter is equal to Preset else OFF. Use SS out if ON duration is too small for relay ON time.
Conf 8				OUT is ON when counter is greater or equal to Preset else OFF. Use NC pin of OUT if less then is required

■ Pulse

□ Latched Output