

**IN74AC193**

**Presettable 4-Bit Binary UP/DOWN Counter**  
**High-Speed Silicon-Gate CMOS**

The IN74AC193 is identical in pinout to the LS/ALS193, HC/HCT193. The device inputs are compatible with standard CMOS outputs; with pullup resistors, they are compatible with LS/ALS outputs.

The counter has two separate clock inputs, a Count Up Clock and Count Down Clock inputs. The direction of counting is determined by which input is clocked. The outputs change state synchronous with the LOW-to-HIGH transitions on the clock inputs. This counter may be preset by entering the desired data on the P0, P1, P2, P3 input. When the Parallel Load input is taken low the data is loaded independently of either clock input. This feature allows the counters to be used as divide-by-n by modifying the count length with the preset inputs. In addition the counter can also be cleared. This is accomplished by inputting a high on the Master Reset input. All 4 internal stages are set to low independently of either clock input. Both a Terminal Count Down (TC<sub>D</sub>) and Terminal Count Up (TC<sub>U</sub>) Outputs are provided to enable cascading of both up and down counting functions. The TC<sub>D</sub> output produces a negative going pulse when the counter underflows and TC<sub>U</sub> outputs a pulse when the counter overflows. The counter can be cascaded by connecting the TC<sub>U</sub> and TC<sub>D</sub> outputs of one device to the Count Up Clock and Count Down Clock inputs, respectively, of the next device.

- Outputs Directly Interface to CMOS, NMOS, and TTL
- Operating Voltage Range: 2.0 to 6.0 V
- Low Input Current: 1.0  $\mu$ A; 0.1  $\mu$ A @ 25°C
- High Noise Immunity Characteristic of CMOS Devices
- Outputs Source/Sink 24 mA

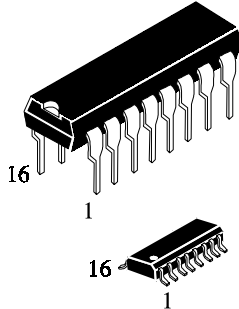

**N SUFFIX PLASTIC**

**D SUFFIX SOIC**

**ORDERING INFORMATION**  
 IN74AC193N Plastic  
 IN74AC193D SOIC  
 T<sub>A</sub> = -40° to 85° C for all packages

**PIN ASSIGNMENT**

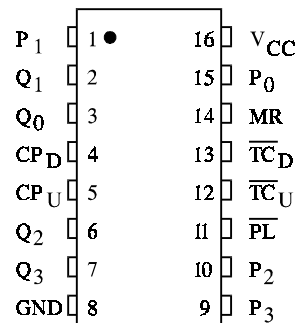

**LOGIC DIAGRAM**

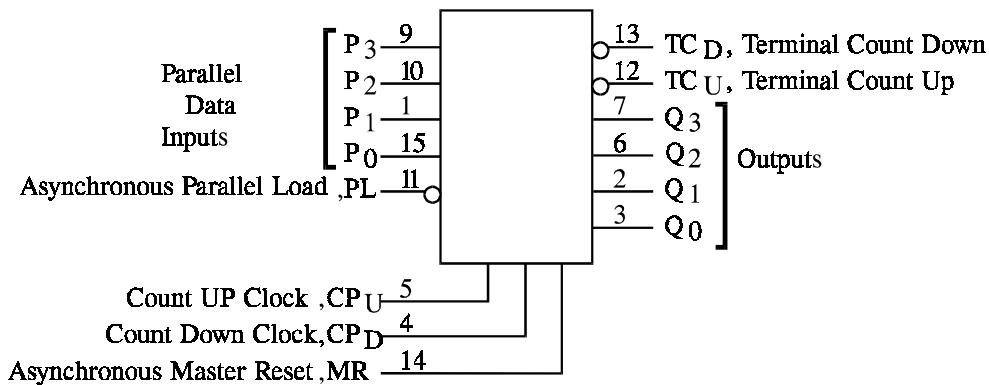

PIN 16 = V<sub>CC</sub>  
 PIN 8 = GND

**MAXIMUM RATINGS\***

Symbol	Parameter	Value	Unit
$V_{CC}$	DC Supply Voltage (Referenced to GND)	-0.5 to +7.0	V
$V_{IN}$	DC Input Voltage (Referenced to GND)	-0.5 to $V_{CC} + 0.5$	V
$V_{OUT}$	DC Output Voltage (Referenced to GND)	-0.5 to $V_{CC} + 0.5$	V
$I_{IN}$	DC Input Current, per Pin	$\pm 20$	mA
$I_{OUT}$	DC Output Sink/Source Current, per Pin	$\pm 50$	mA
$I_{CC}$	DC Supply Current, $V_{CC}$ and GND Pins	$\pm 50$	mA
$P_D$	Power Dissipation in Still Air, Plastic DIP+ SOIC Package+	750 500	mW
$T_{stg}$	Storage Temperature	-65 to +150	$^{\circ}C$
$T_L$	Lead Temperature, 1 mm from Case for 10 Seconds (Plastic DIP or SOIC Package)	260	$^{\circ}C$

\*Maximum Ratings are those values beyond which damage to the device may occur.  
Functional operation should be restricted to the Recommended Operating Conditions.

+Derating - Plastic DIP: - 10 mW/ $^{\circ}C$  from 65 $^{\circ}$  to 125 $^{\circ}C$   
SOIC Package: : - 7 mW/ $^{\circ}C$  from 65 $^{\circ}$  to 125 $^{\circ}C$

**RECOMMENDED OPERATING CONDITIONS**

Symbol	Parameter	Min	Max	Unit	
$V_{CC}$	DC Supply Voltage (Referenced to GND)	2.0	6.0	V	
$V_{IN}, V_{OUT}$	DC Input Voltage, Output Voltage (Referenced to GND)	0	$V_{CC}$	V	
$T_J$	Junction Temperature (PDIP)		140	$^{\circ}C$	
$T_A$	Operating Temperature, All Package Types	-40	+85	$^{\circ}C$	
$I_{OH}$	Output Current - High		-24	mA	
$I_{OL}$	Output Current - Low		24	mA	
$t_r, t_f$	Input Rise and Fall Time * (except Schmitt Inputs)	$V_{CC} = 3.0$ V $V_{CC} = 4.5$ V $V_{CC} = 5.5$ V	0 0 0	150 40 25	ns/V

\*  $V_{IN}$  from 30% to 70%  $V_{CC}$

This device contains protection circuitry to guard against damage due to high static voltages or electric fields. However, precautions must be taken to avoid applications of any voltage higher than maximum rated voltages to this high-impedance circuit. For proper operation,  $V_{IN}$  and  $V_{OUT}$  should be constrained to the range  $GND \leq (V_{IN} \text{ or } V_{OUT}) \leq V_{CC}$ .

Unused inputs must always be tied to an appropriate logic voltage level (e.g., either GND or  $V_{CC}$ ).  
Unused outputs must be left open.

**DC ELECTRICAL CHARACTERISTICS**(Voltages Referenced to GND)





Symbol	Parameter	Test Conditions	V <sub>CC</sub> V	Guaranteed Limits		Unit	
				25 °C	-40°C to 85°C		
V <sub>IH</sub>	Minimum High-Level Input Voltage	V <sub>OUT</sub> =0.1 V or V <sub>CC</sub> -0.1 V	3.0	2.1	2.1	V	
			4.5	3.15	3.15		
			5.5	3.85	3.85		
V <sub>IL</sub>	Maximum Low -Level Input Voltage	V <sub>OUT</sub> =0.1 V or V <sub>CC</sub> -0.1 V	3.0	0.9	0.9	V	
			4.5	1.35	1.35		
			5.5	1.65	1.65		
V <sub>OH</sub>	Minimum High-Level Output Voltage	I <sub>OUT</sub> ≤ -50 μA	3.0	2.9	2.9	V	
			4.5	4.4	4.4		
			5.5	5.4	5.4		
		*V <sub>IN</sub> =V <sub>IH</sub> or V <sub>IL</sub>		3.0	2.56		2.46
		I <sub>OH</sub> =-12 mA		4.5	3.86		3.76
I <sub>OH</sub> =-24 mA		5.5	4.86	4.76			
V <sub>OL</sub>	Maximum Low-Level Output Voltage	I <sub>OUT</sub> ≤ 50 μA	3.0	0.1	0.1	V	
			4.5	0.1	0.1		
			5.5	0.1	0.1		
		*V <sub>IN</sub> =V <sub>IH</sub> or V <sub>IL</sub>		3.0	0.36		0.44
		I <sub>OL</sub> =12 mA		4.5	0.36		0.44
I <sub>OL</sub> =24 mA		5.5	0.36	0.44			
I <sub>IN</sub>	Maximum Input Leakage Current	V <sub>IN</sub> =V <sub>CC</sub> or GND	5.5	±0.1	±1.0	μA	
I <sub>OLD</sub>	+Minimum Dynamic Output Current	V <sub>OLD</sub> =1.65 V Max	5.5		75	mA	
I <sub>OHD</sub>	+Minimum Dynamic Output Current	V <sub>OHD</sub> =3.85 V Min	5.5		-75	mA	
I <sub>CC</sub>	Maximum Quiescent Supply Current (per Package)	V <sub>IN</sub> =V <sub>CC</sub> or GND	5.5	8.0	80	μA	

\* All outputs loaded; thresholds on input associated with output under test.

+Maximum test duration 2.0 ms, one output loaded at a time.

Note: I<sub>IN</sub> and I<sub>CC</sub> @ 3.0 V are guaranteed to be less than or equal to the respective limit @ 5.5 V V<sub>CC</sub>

**FUNCTION TABLE**

MR	Inputs			Mode
	$\overline{PL}$	CP <sub>U</sub>	CP <sub>D</sub>	
H	X	X	X	Reset(Asyn.)
L	L	X	X	Preset(Asyn.)
L	H		H	No Count
L	H		H	Count Up
L	H	H		Count Down
L	H	H		No Count

X = don't care

The IN74AC193 is an UP/DOWN MODULO-16 Binary Counter.

Logic equations

For Terminal Count:

$$TC_U = Q_0 \cdot Q_1 \cdot Q_2 \cdot Q_3 \cdot \overline{CP_U}$$

$$TC_D = \overline{Q_0} \cdot \overline{Q_1} \cdot \overline{Q_2} \cdot \overline{Q_3} \cdot \overline{CP_D}$$

**AC ELECTRICAL CHARACTERISTICS**( $C_L=50\text{pF}$ , Input  $t_r=t_f=3.0\text{ ns}$ )

Symbol	Parameter	$V_{CC}^*$ V	Guaranteed Limits				Unit
			25 °C		-40°C to 85°C		
			Min	Max	Min	Max	
$f_{max}$	Maximum Clock Frequency (Figure 1)	3.3 5.0	88 120		40 55		MHz
$t_{PLH}$	Propagation Delay, $CP_U$ or $CP_D$ to $\overline{TC_U}$ or $TC_D$ (Figure 2)	3.3 5.0		20 13		22 14.5	ns
$t_{PHL}$	Propagation Delay, $CP_U$ or $CP_D$ to $\overline{TC_U}$ or $TC_D$ (Figure 2)	3.3 5.0		19 11.5		21 13.0	ns
$t_{PLH}$	Propagation Delay, $CP_U$ or $CP_D$ to $Q_n$ (Figure 1)	3.3 5.0		15 10		17.0 11.5	ns
$t_{PHL}$	Propagation Delay, $CP_U$ or $CP_D$ to $Q_n$ (Figure 1)	3.3 5.0		15 9.5		17.0 11	ns
$t_{PLH}$	Propagation Delay, $P_n$ to $Q_n$ (Figure 3)	3.3 5.0		15 10		17.0 11.5	ns
$t_{PHL}$	Propagation Delay, $P_n$ to $Q_n$ (Figure 3)	3.3 5.0		15 9.5		17.0 11	ns
$t_{PLH}$	Propagation Delay, $\overline{PL}$ to $Q_n$ (Figure 4)	3.3 5.0		15 10		17 11.5	ns
$t_{PHL}$	Propagation Delay, $\overline{PL}$ to $Q_n$ (Figure 4)	3.3 5.0		20 12.5		22 14	ns
$t_{PHL}$	Propagation Delay, MR to $Q_n$ (Figure 5)	3.3 5.0		20 12.5		22 14	ns
$t_{PLH}$	Propagation Delay, MR to $\overline{TC_U}$ (Figure 6)	3.3 5.0		18 12		20 13.5	ns
$t_{PHL}$	Propagation Delay, MR to $\overline{TC_D}$ (Figure 6)	3.3 5.0		19 11.5		21 13.0	ns
$t_{PLH}$	Propagation Delay, $\overline{PL}$ to $\overline{TC_U}$ or $\overline{TC_D}$ (Figure 6)	3.3 5.0		20 13		22 14.5	ns
$t_{PHL}$	Propagation Delay, $\overline{PL}$ to $\overline{TC_U}$ or $\overline{TC_D}$ (Figure 6)	3.3 5.0		15 8.5		17 10	ns
$t_{PLH}$	Propagation Delay, $P_n$ to $\overline{TC_U}$ or $\overline{TC_D}$ (Figure 6)	3.3 5.0		20 13		22 14.5	ns
$t_{PHL}$	Propagation Delay, $P_n$ to $\overline{TC_U}$ or $\overline{TC_D}$ (Figure 6)	3.3 5.0		20 12.5		22 14	ns
$C_{IN}$	Maximum Input Capacitance	5.0	4.5		4.5		pF
$C_{PD}$	Power Dissipation Capacitance	Typical @25°C, $V_{CC}=5.0\text{ V}$				pF	
		45					

\*Voltage Range 3.3 V is 3.3 V ±0.3 V  
Voltage Range 5.0 V is 5.0 V ±0.5 V

**TIMING REQUIREMENTS**( $C_L=50\text{pF}$ , Input  $t_r=t_f=3.0\text{ ns}$ )

Symbol	Parameter	$V_{CC}^*$ V	Guaranteed Limits		Unit
			25 °C	-40°C to 85°C	
$t_{su}$	Minimum Setup Time, $\overline{P_n}$ to $\overline{PL}$ (Figure 7)	3.3 5.0	9 6	10 7	ns
$t_h$	Minimum Hold Time, $\overline{PL}$ to $P_n$ (Figure 7)	3.3 5.0	-1.0 -1.0	0 0	ns
$t_w$	Minimum Pulse Width, $\overline{PL}$ (Figure 4)	3.3 5.0	17 12	21 13	ns
$t_w$	Minimum Pulse Width, $CP_U$ or $CP_D$ (Figure 1)	3.3 5.0	11 8	12 9	ns
$t_w$	Minimum Pulse Width, MR (Figure 5)	3.3 5.0	14 10	16 12	ns
$t_{rec}$	Minimum Recovery Time, $\overline{PL}$ to $CP_U$ or $CP_D$ (Figure 5)	3.3 5.0	9 12	10 13	ns
$t_{rec}$	Minimum Recovery Time, MR to $CP_U$ or $CP_D$ (Figure 5)	3.3 5.0	17 12	21 14	ns

\*Voltage Range 3.3 V is 3.3 V  $\pm$ 0.3 V  
Voltage Range 5.0 V is 5.0 V  $\pm$ 0.5 V

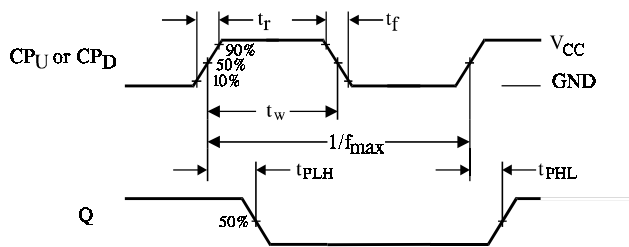

Figure 1. Switching Waveforms

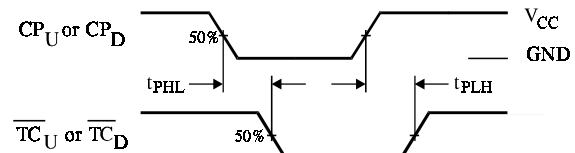

Figure 2. Switching Waveforms

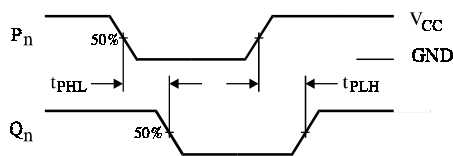

Figure 3. Switching Waveforms

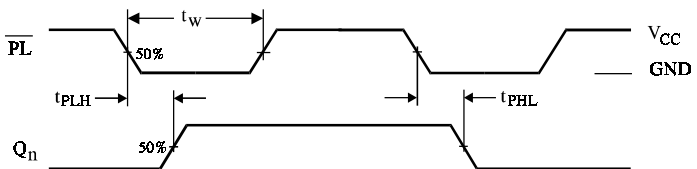

Figure 4. Switching Waveforms

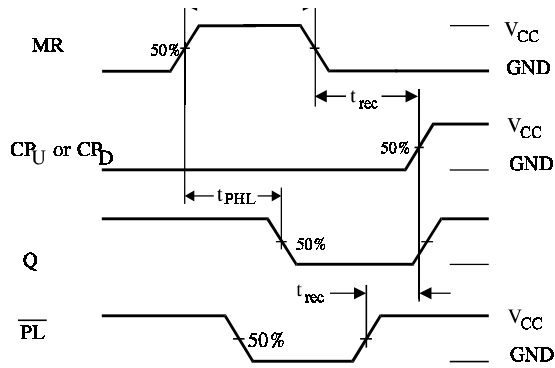

Figure 5. Switching Waveforms

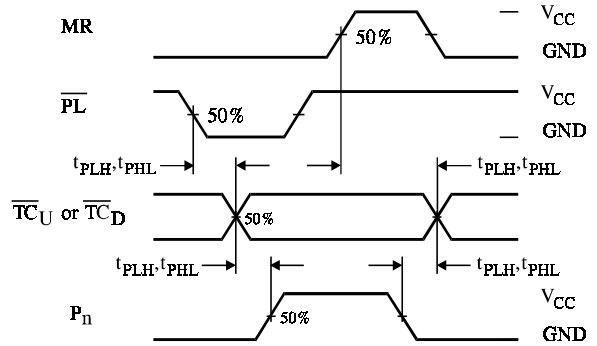

Figure 6. Switching Waveforms

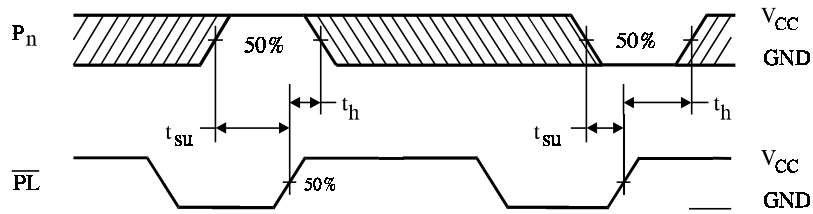
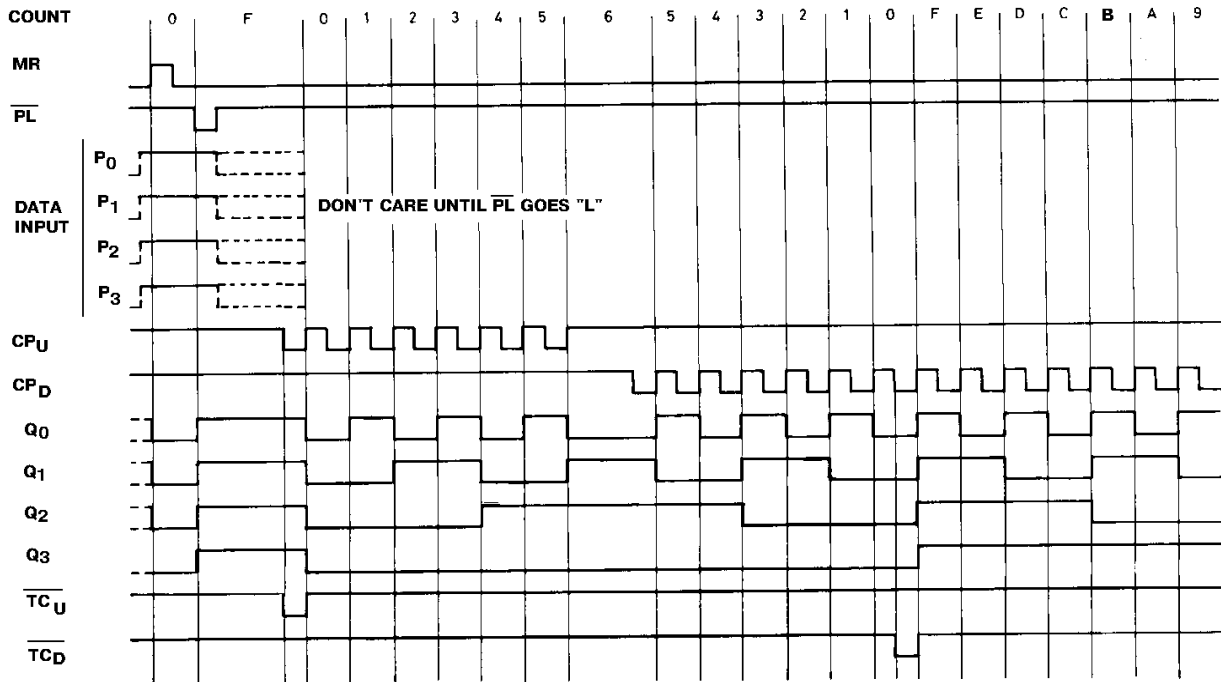

Figure 7. Switching Waveforms

TIMING DIAGRAM



EXPANDED LOGIC DIAGRAM

