

# ACT-VS-36B(R/H) – Actuator, 36” Ball Screw with Reed/Hall Sensor

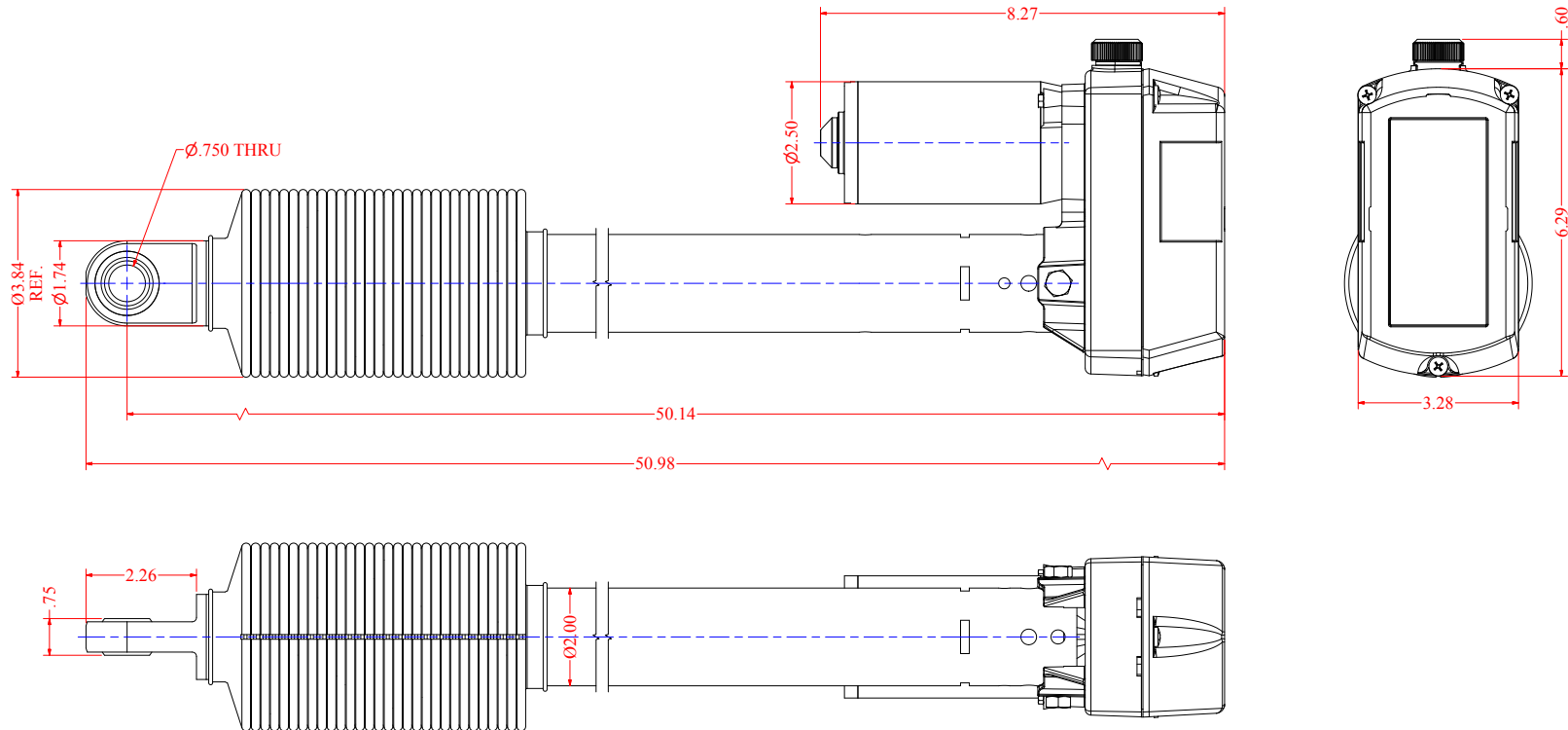

MA-813B-36R (NO CLAMP)  
 MA-834138503-36B  
 36V DC MOTOR  
 58:1 RATIO  
 REED/HALL SENSOR  
 LIMIT SWITCHES  
 CLUTCH  
 850 SERIES (2.00" OUTER TUBE)  
 5/8-5 R.H. BALL SCREW  
 NO TUBE MOUNTING  
 3/4" SWIVEL END MOUNT  
 36" STROKE  
 TUBE BOOT