

Caution

Do Not Fully Tighten

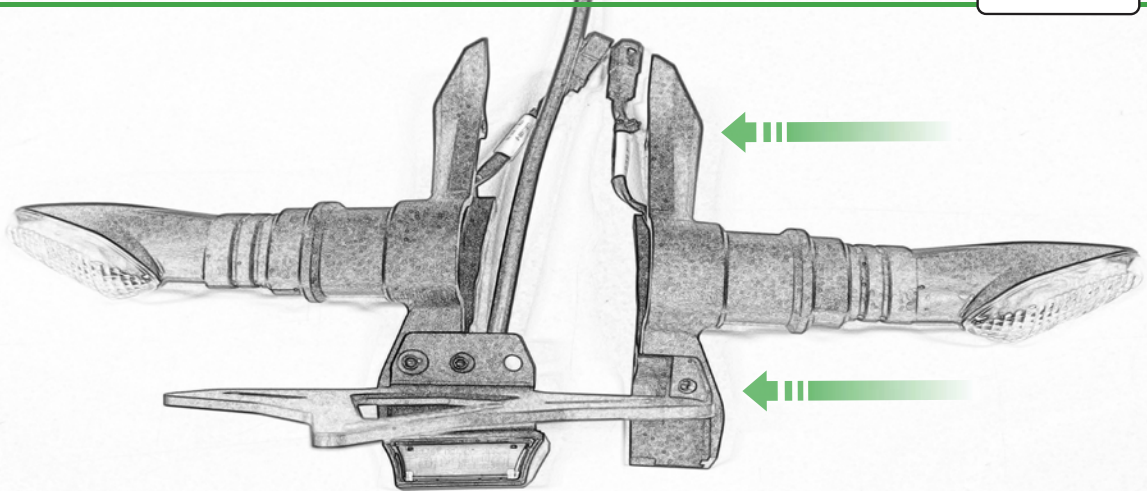

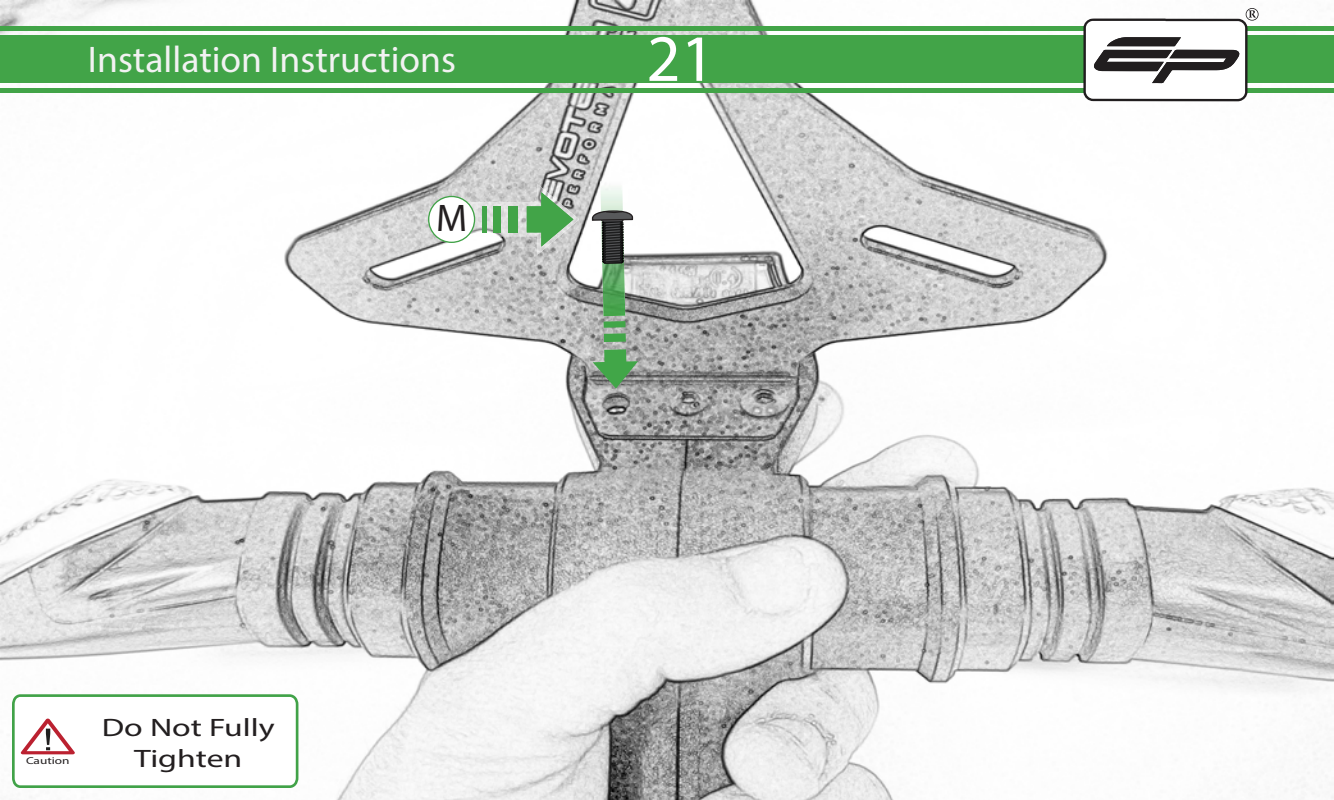

Caution

Do Not Fully Tighten

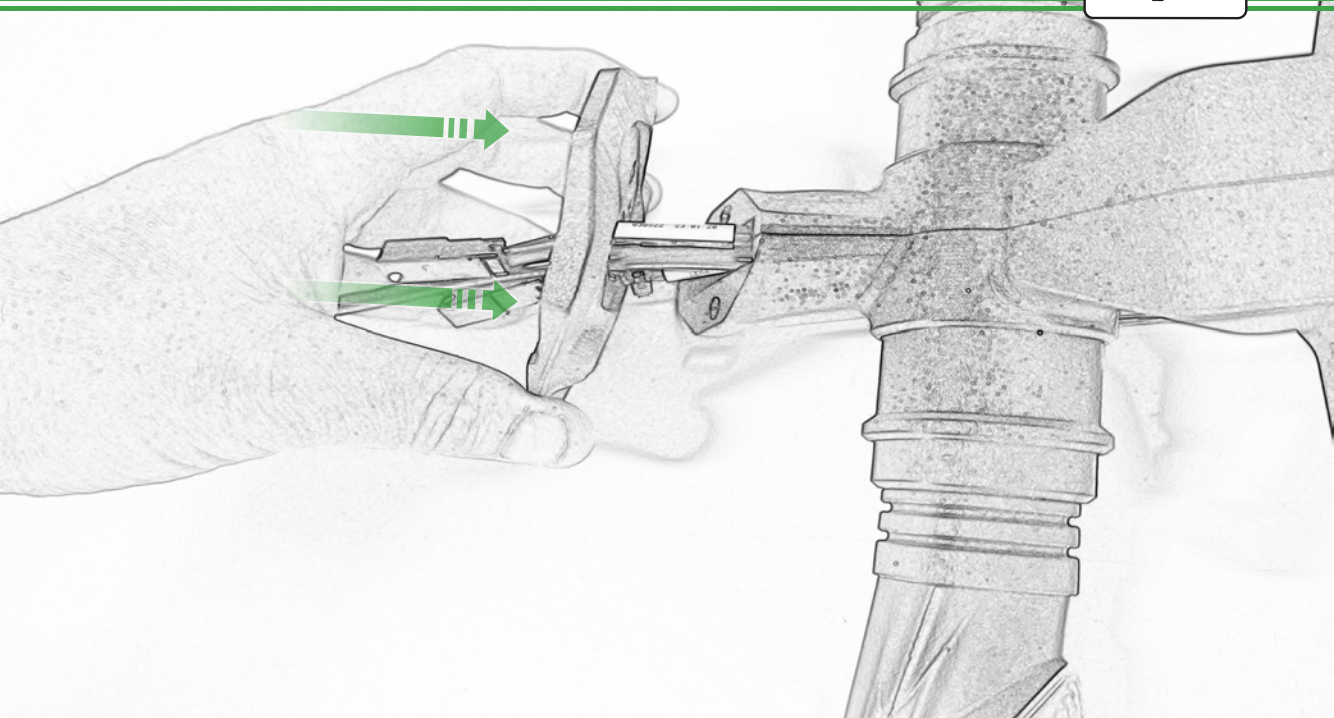

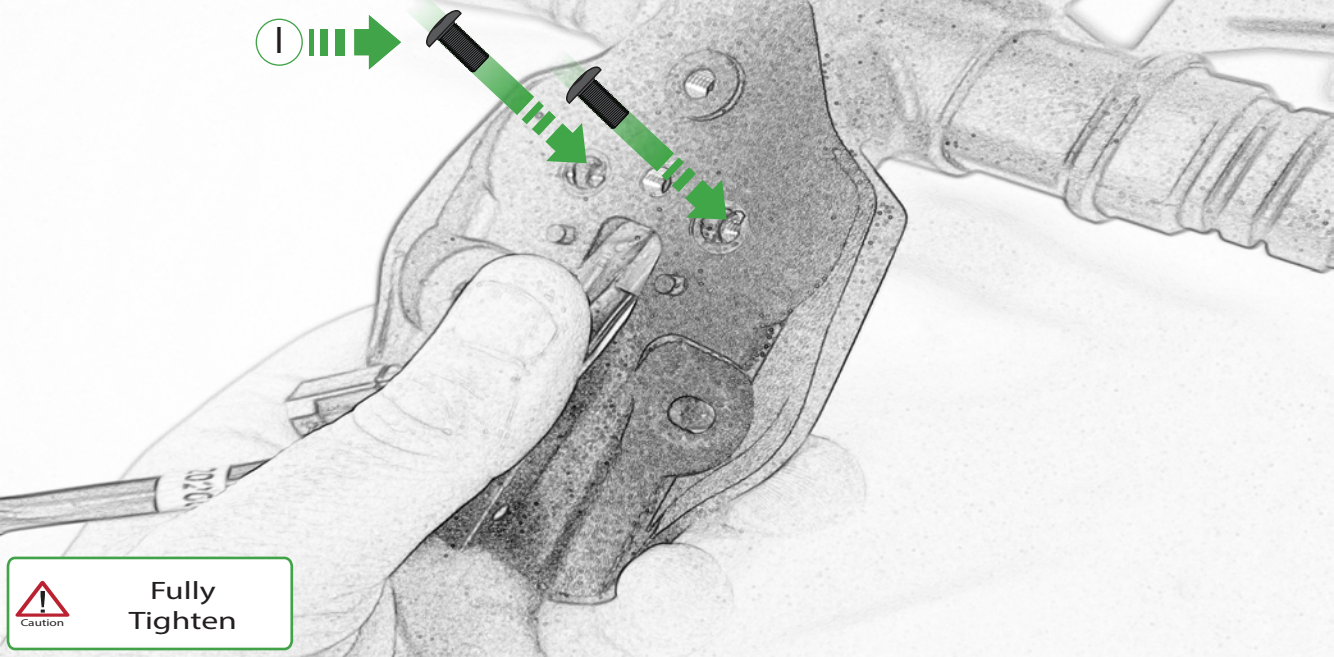

Caution

Fully  
Tighten

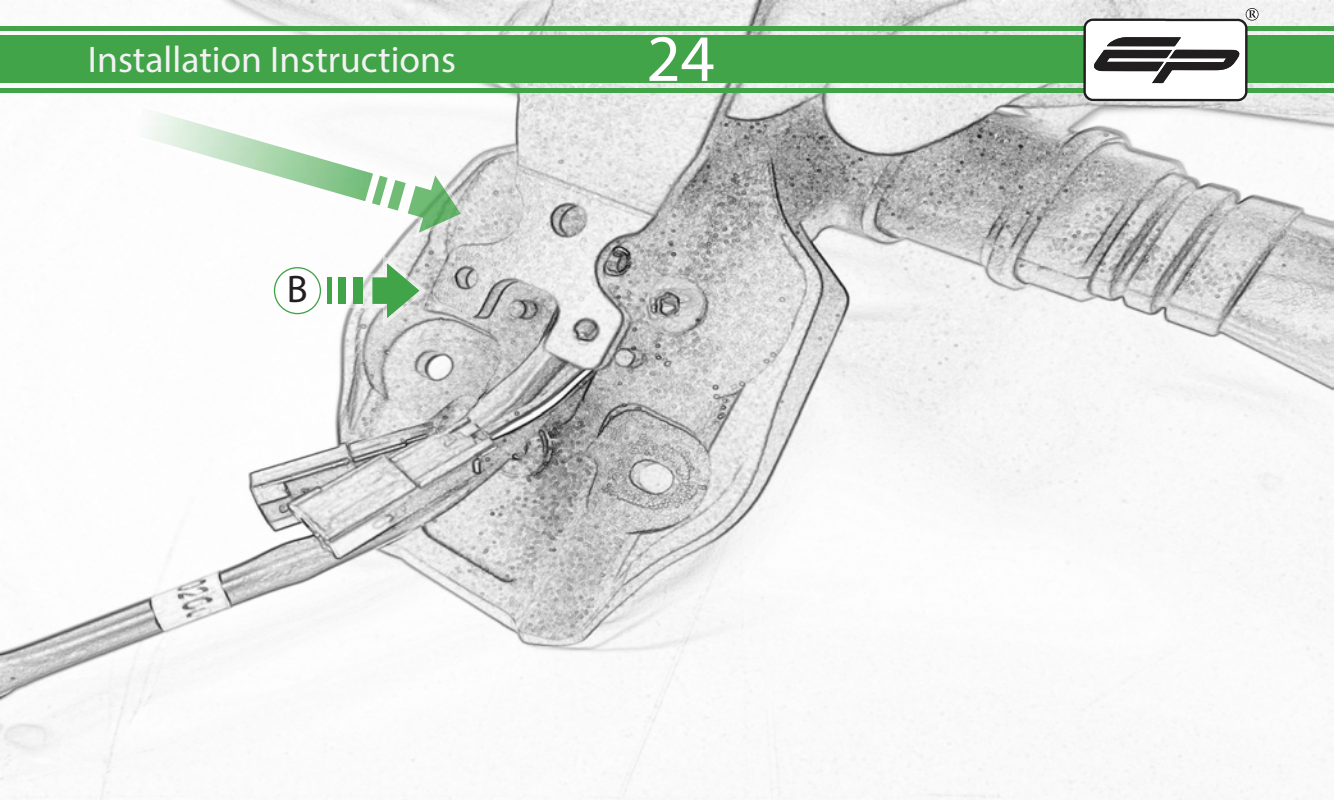

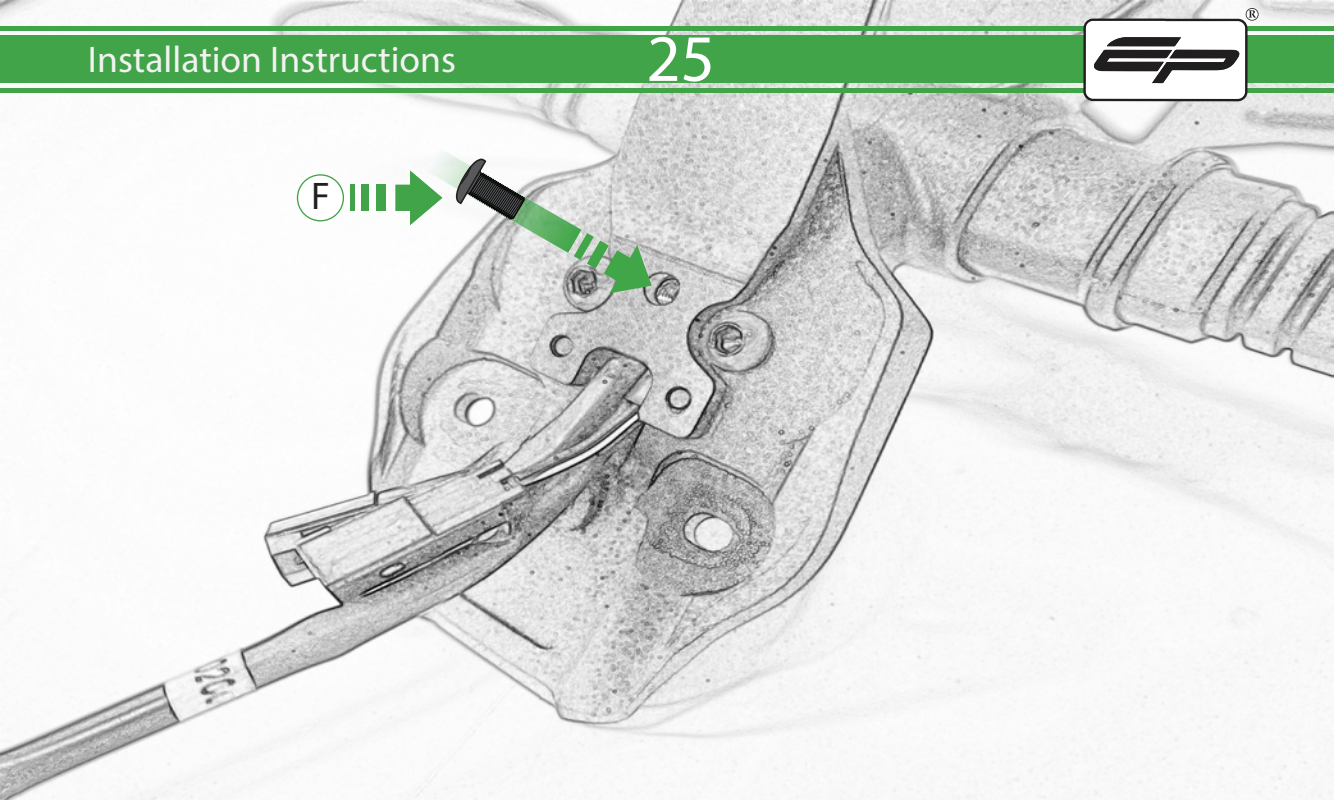

F

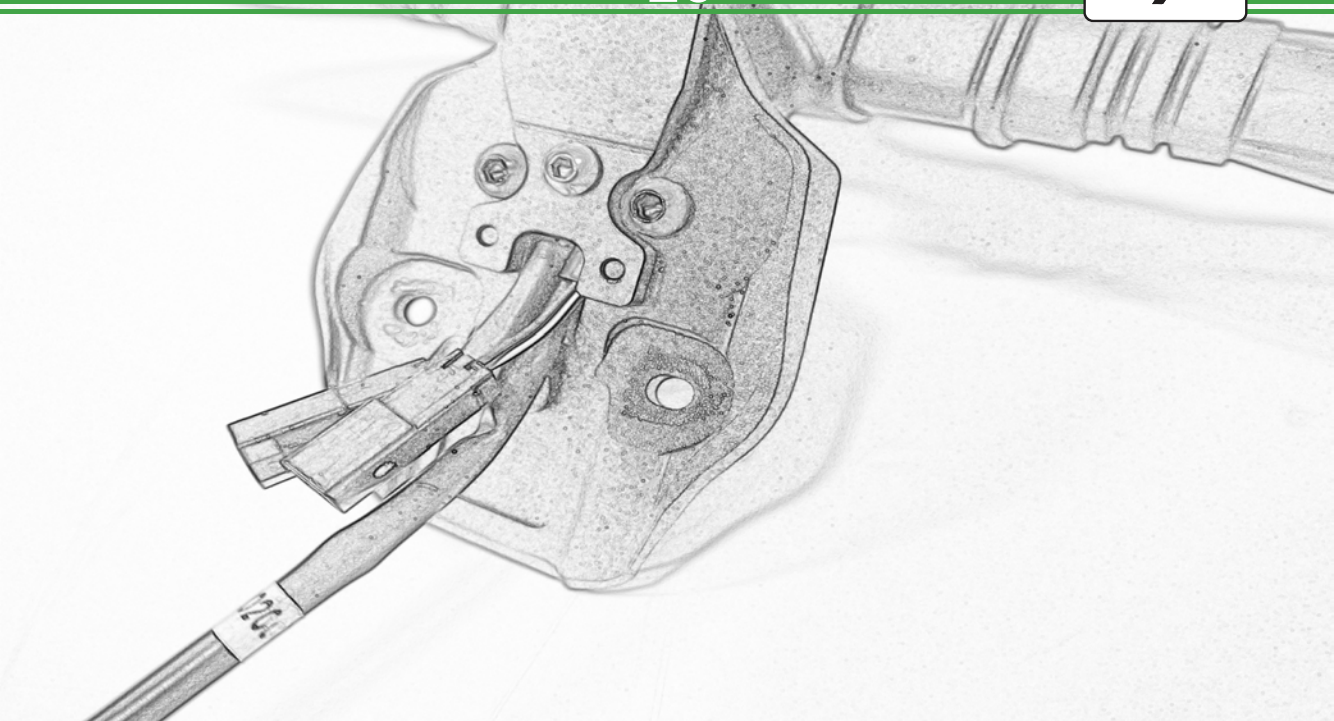



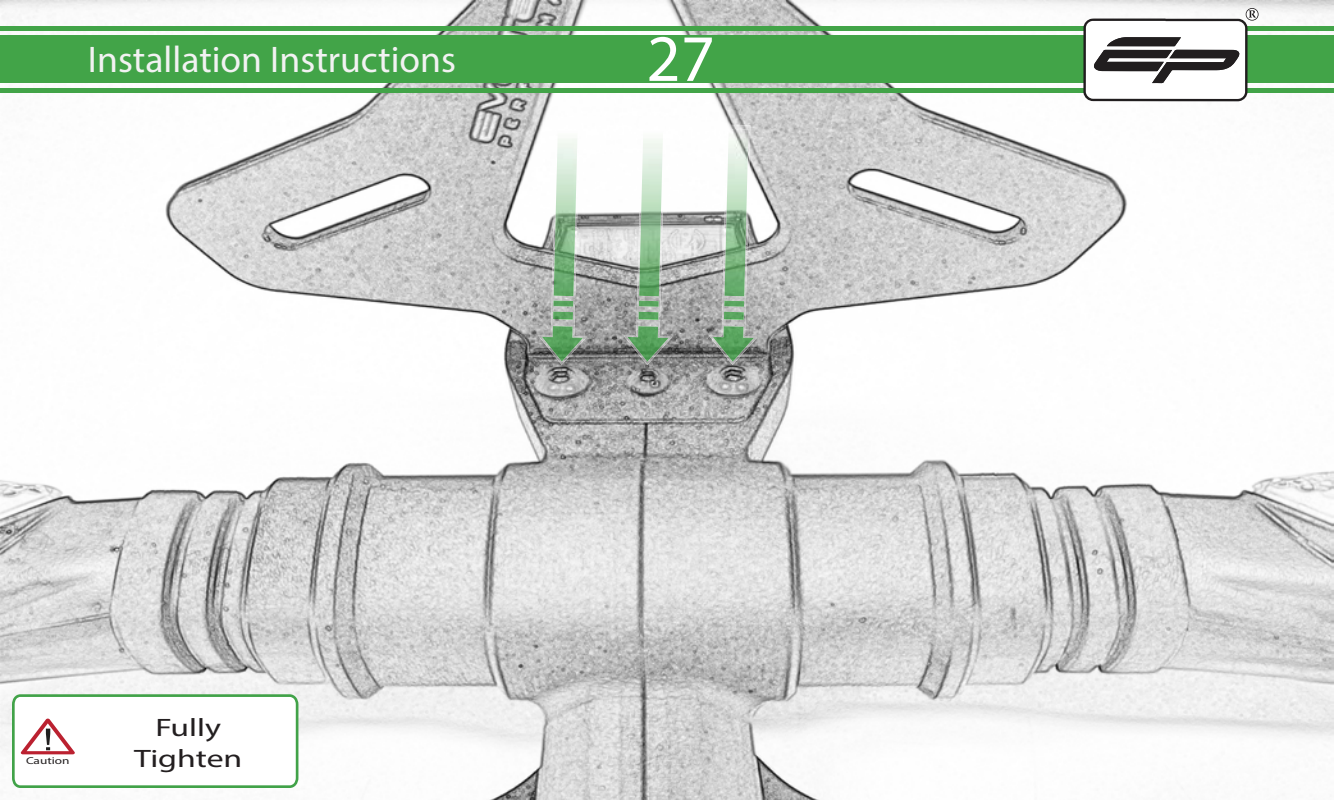

Caution

Fully  
Tighten

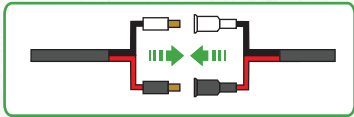
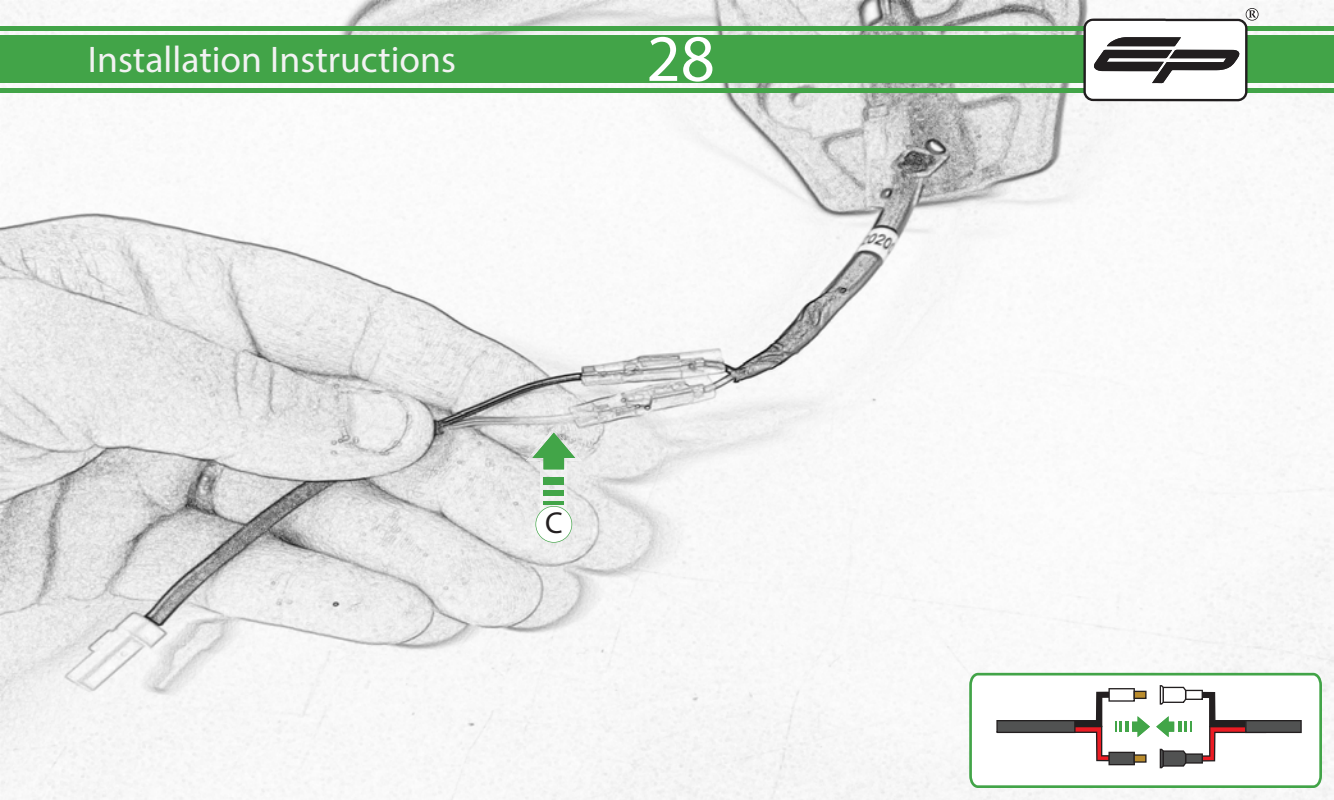

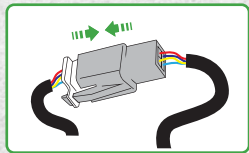
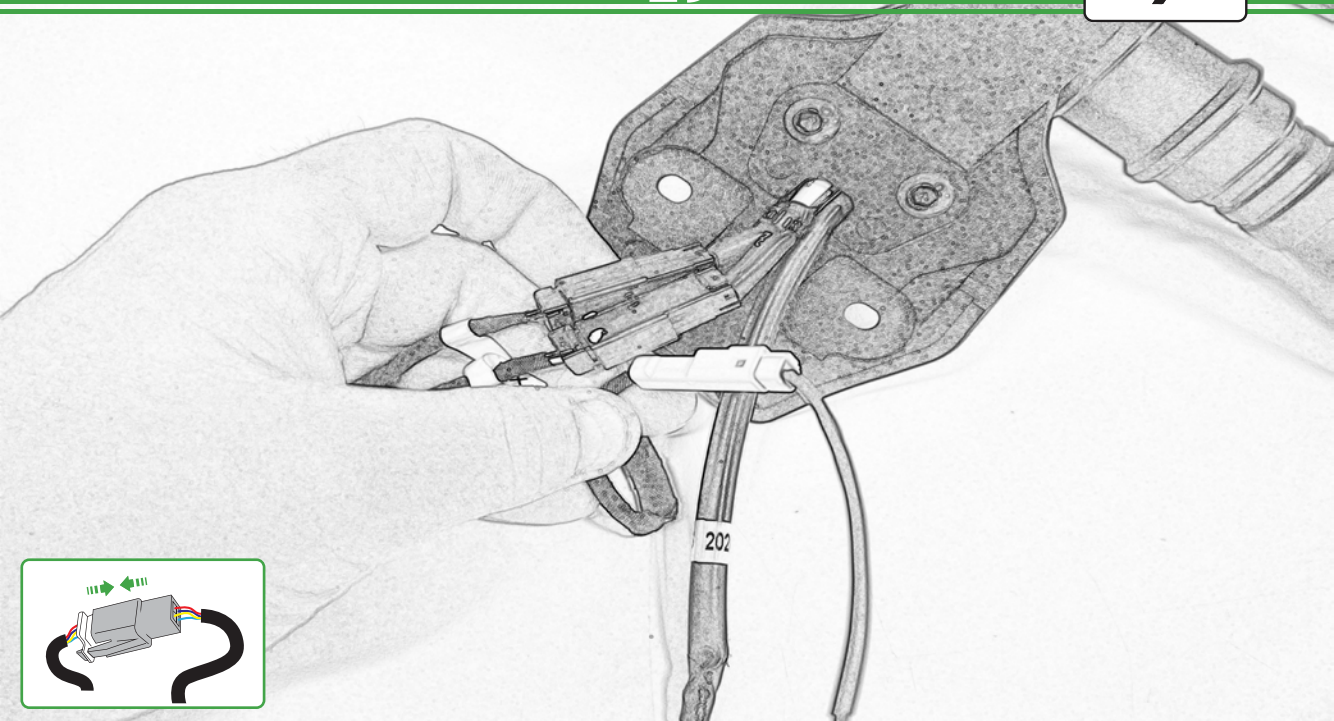

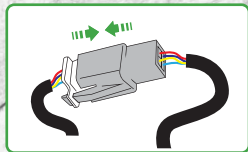
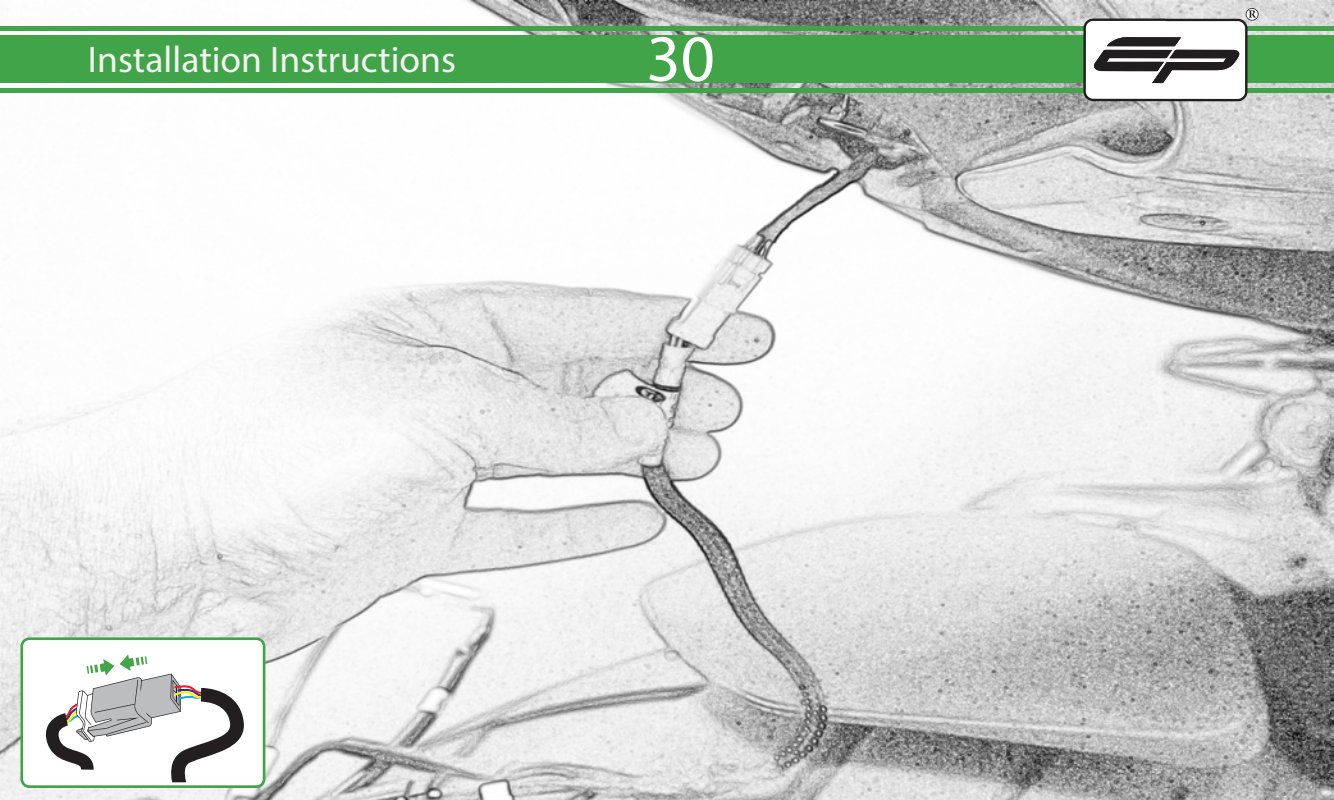

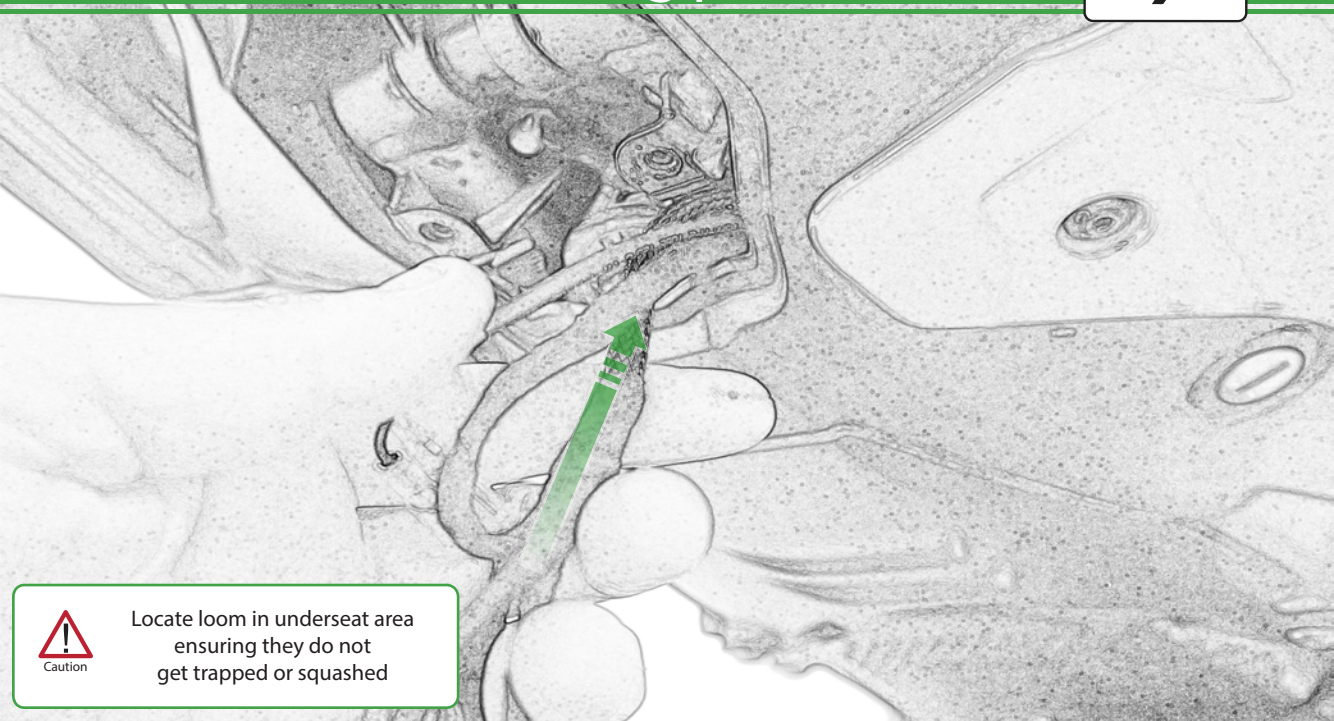

Caution

Locate loom in underseat area ensuring they do not get trapped or squashed



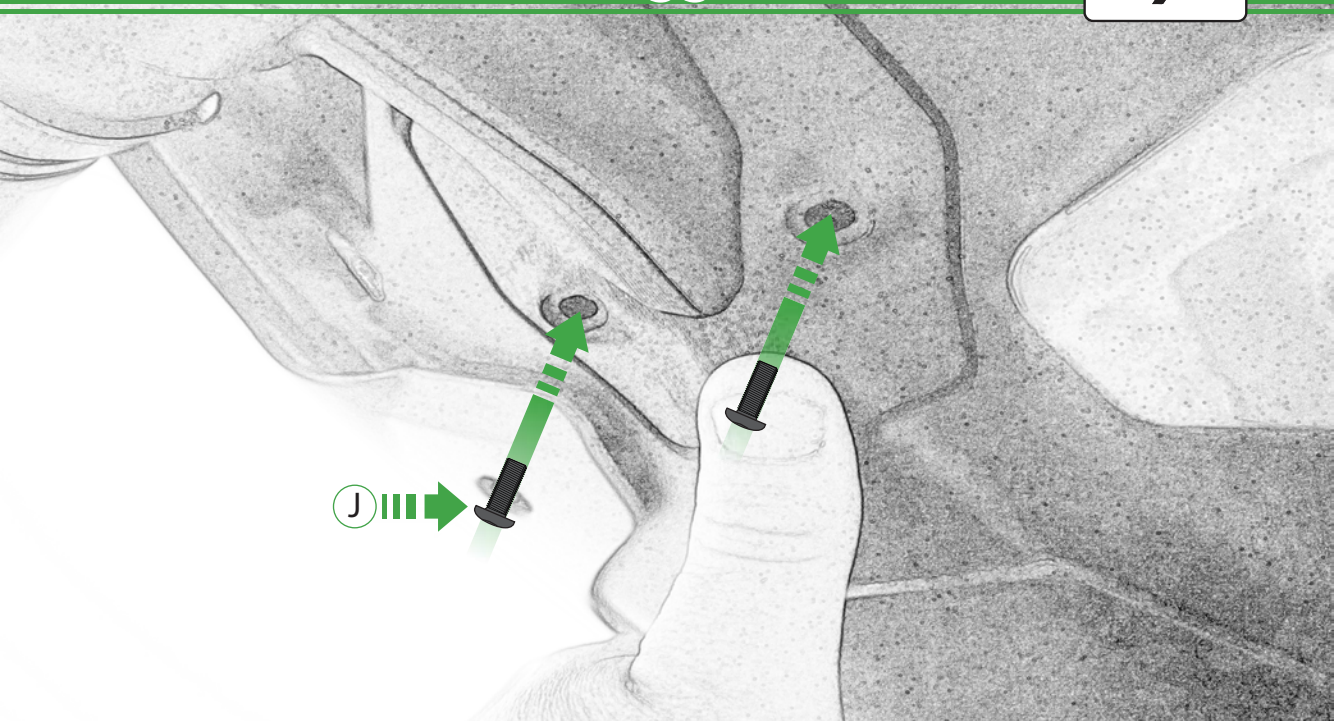

J

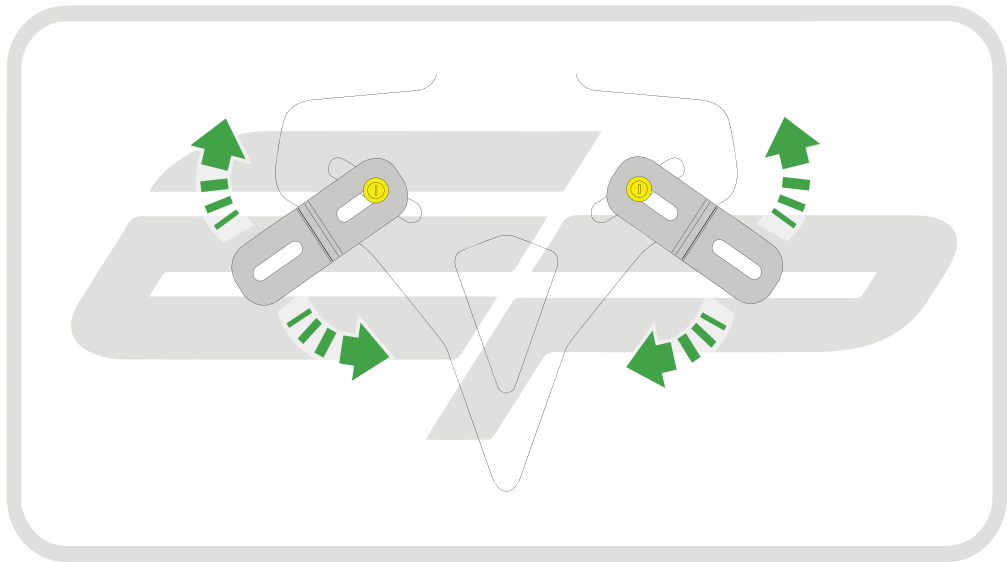

**EVOTECH**<sup>®</sup>  
P E R F O R M A N C E



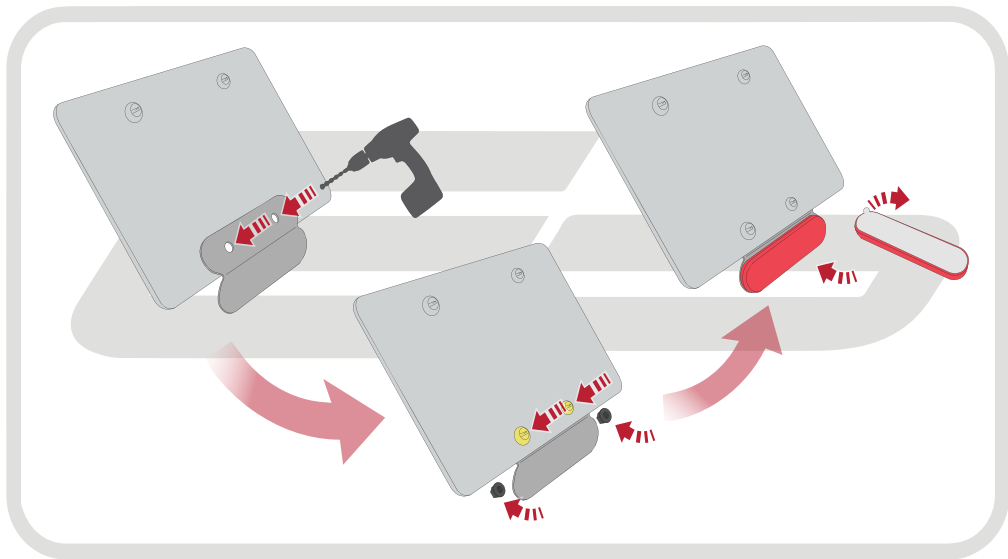



## ESSENTIAL CHECKS



After installation of your tail tidy ensure that the licence plate does not contact the rear tyre when suspension is fully compressed.

Ensure all electrics including indicators, tail light, brake light and licence plate light lights are working correctly before riding the motorcycle.

It is recommended that periodic inspections are made to ensure that all fixings are fully tightend.



**EVOTECH**®  
P E R F O R M A N C E

[www.evotech-performance.com](http://www.evotech-performance.com)