

Operating Limits:

- Max. operating pressure: 12 bar
- Head up to 95m
- Liquid temperature up to +105°C
- Max. ambient temperature: 40°C
- Max. altitude: 1000m

Motor:

- Three phase induction motor
- Insulation Class B
- Protection IPX4
- Continuous duty
- Standard voltage:
 - Three-phase: 220/380-50Hz up to 3KW(4HP)
 - 380/660V-50Hz from 4KW(5.5HP)
 - to 37KW(50HP)

Material:

- Pump body: Cast Iron/ Stainless Steel
- Impeller: Cast Iron
- Motor Shaft: Stainless Steel
- Mechanical seal: SiC/Graphite
- Motor housing: Cast Iron

Application:

- Circulation and transfer of clean, chemical non-aggressive water and other liquids
- Water supply & irrigation
- Water circulation in air conditioning systems



CM



Application:

- Single-impeller centrifugal pump featuring axial intake and radial discharge
- Inlet and outlet DN in compliance with EN 733 (ex DIN 24255) and UNI 7467
- Flanges in compliance with UNI 2236 and DIN 2532
- Rear entry (impeller, control valve and motor can be extracted without disconnecting the pump body from the pipes.)

Material CM:

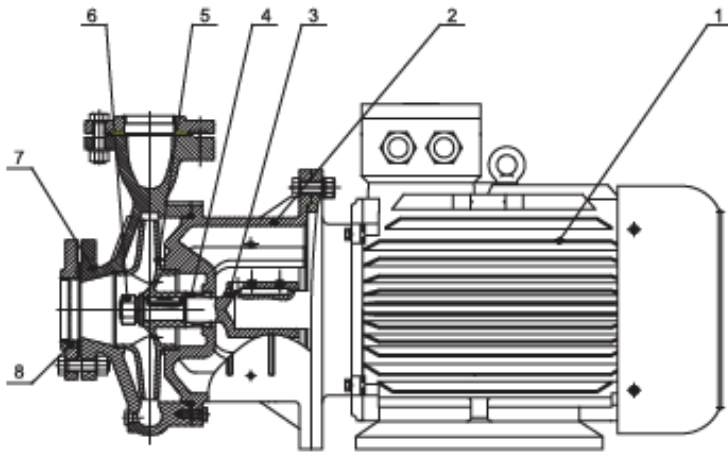

NO.	NAME	MATERIAL
1	Motor	
2	Support	HT 200
3	Pump Shaft	Steel/AISI 304
4	Mechanical Seal	Carbon/Silicon carbide
5	Impeller	HT 200/Stainless Steel
6	Nut	AISI 304
7	Pump Body	HT 200
8	Flange	HT 200

65-125

2900rpm

