

**LA3370**

## PLL FM Multiplex Stereo Demodulator for Car Stereo

### Overview

The LA3370 is a multiplex IC for FM car stereo, and it has the following 2 functions through its utilization of the IF meter output voltage, etc.

1. Stereo noise control (SNC) under which the noise particular to the FM stereo unit in the weak electric field is reduced smoothly.
2. High-cut control (HCC) under which the high frequency is smoothly attenuated. In addition, the LA3370 can be, due to its low distortion factor, an IC for multiplex stereo demodulator which is appropriate for the car component stereo unit.

### Functions

- Stereo noise control (SNC terminal)

Through controlling the quality of sound from stereo mode to monaural mode with the voltage applied to the control pin, the FM stereo noise in the weak electric field is reduced by this function.

- High-cut control function (HCC terminal)

The FM noise in the weak electric field is reduced through the attenuation of high frequency thereof.

Such attenuation can be changed smoothly from "Normal" to "High Cut" by controlling the voltage applied to the control pin. The volume of "High Cut" can be selected by using an external capacitor.

- Stereo-monaural automatic select

This selection has priority over the stereo noise control. Pilot input prioritized.

- Stoppage of VCO oscillation

When a voltage of 7.5V or higher is applied to the HCC terminal, the oscillation of VCO can be discontinued. In this case, the stereo lamp does not malfunction.

- With separation control terminal.

### Features

- Low distortion factor. (0.05% typ. 300mV input, mono)
- The ripple of power source can effectively be rejected. (35dB typ.)
- The range of voltage to be used is wide. ( $V_{CC}=6.5$  to 14V)
- The space factor is advantageous because of the single-end package.
- The printed circuit board can easily be prepared as 3mm pitch is used between the pins.

### Package Dimensions

unit: mm

#### 3020A-SIP16

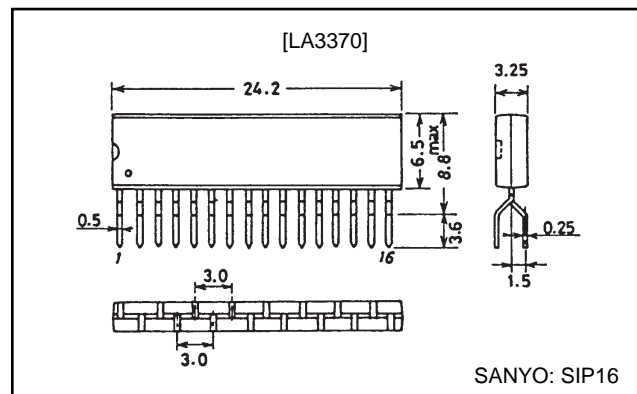

# LA3370

## Specifications

### Maximum Ratings at Ta=25°C

Parameter	Symbol	Conditions	Ratings	Unit
Maximum supply voltage	V <sub>CC</sub> max		16	V
Lamp driving current	I <sub>L</sub>		40	mA
Allowable power dissipation	Pd max	Ta≤45°C	520	mW
Operating temperature	T <sub>opr</sub>		-20 to +70	°C
Storage temperature	T <sub>stg</sub>		-40 to +125	°C

### Recommended Operating Conditions at Ta=25°C

Parameter	Symbol	Conditions	Ratings	Unit
Recommended supply voltage	V <sub>CC</sub>		6.5 to 14	V
Input signal voltage	V <sub>IN</sub>		200 to 300	mV

### Operation Characteristics at Ta=25°C, V<sub>CC</sub>=10V, V<sub>IN</sub>=300mV, f=1kHz, L+R=90%, pilot=10%

See specified Test Circuit.

Parameter	Symbol	Conditions	Ratings			Unit
			min	typ	max	
Quiescent current	I <sub>cco</sub>			21	27	mA
Channel separation	Sep		40	50		dB
Monaural distortion	mono THD	Mono=300mV		0.05	0.2	%
Stereo distortion	ST THD	Main		0.05	0.2	%
Lamp turning-on level	V <sub>L</sub>	L+R=90%, pilot=10%	60	85	120	mV
Hysteresis	hy			3	6	dB
Capture range	CR	Pilot=30mV		±3		%
Output signal level	V <sub>O</sub>	Sub	140	200	280	mV
S/N ratio	S/N		70	78		dB
Input resistance	r <sub>i</sub>			20		kΩ
SCA rejection	SCA <sub>rej</sub>			80		dB
Allowable input voltage	V <sub>IN</sub>	THD=1%	700	800		mV
SNC output attenuation	A <sub>tt</sub> SNC	V <sub>8</sub> =0.6V, L-R=90%, pilot=10%	-8.5	-3.0	-0.3	dB
SNC output voltage	V <sub>O</sub> sub	V <sub>8</sub> =0.1V, L-R=90%, pilot=10%			5	mV
HCC output attenuation	A <sub>tt</sub> HCC 1	V <sub>7</sub> =0.6V, L+R=90%, pilot=10%	-15.0	-6.0	-0.5	dB
	A <sub>tt</sub> HCC 2	V <sub>7</sub> =1V, L+R=90%, pilot=10%	-2.0		0	dB
Power ripple rejection	R <sub>r</sub>			35		dB
VCO stopping voltage	V <sub>CO</sub> stop			6.8		V
Channel balance	CH Ba			0.5	1.5	dB

## Test Circuit

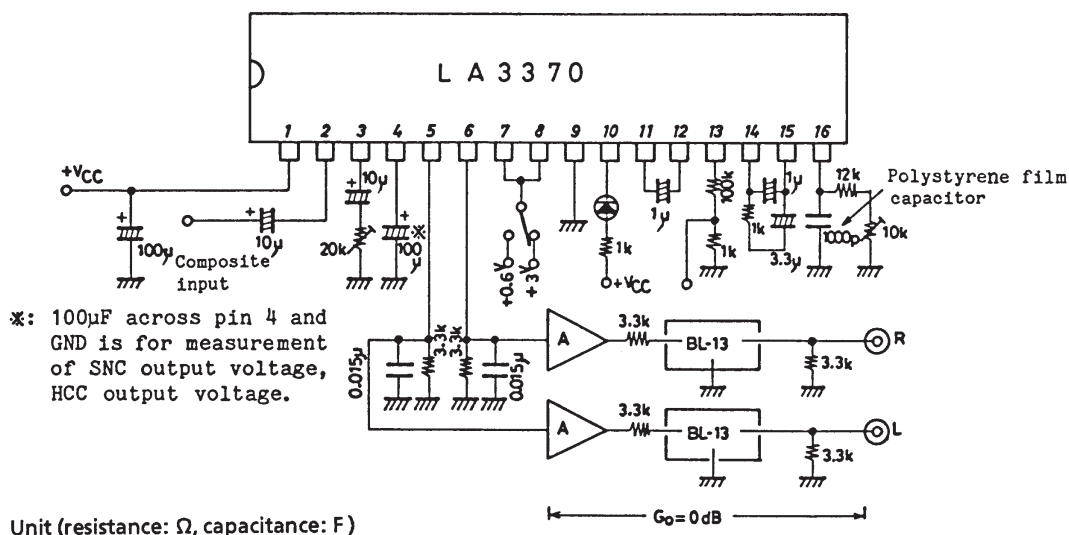

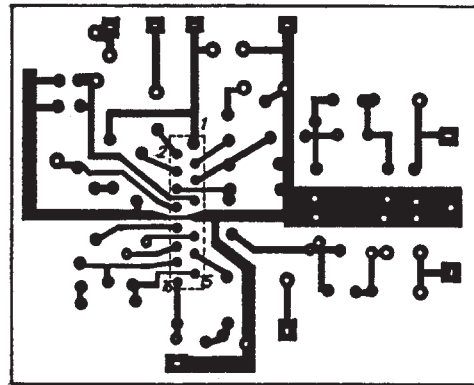
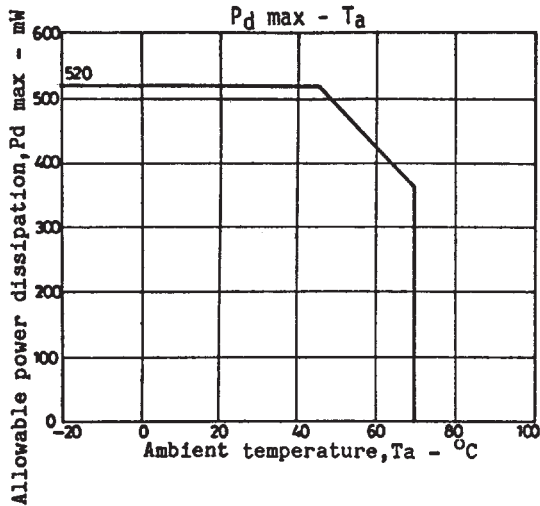

Printed circuit pattern

Sample Application Circuit and Equivalent Circuit Block Diagram

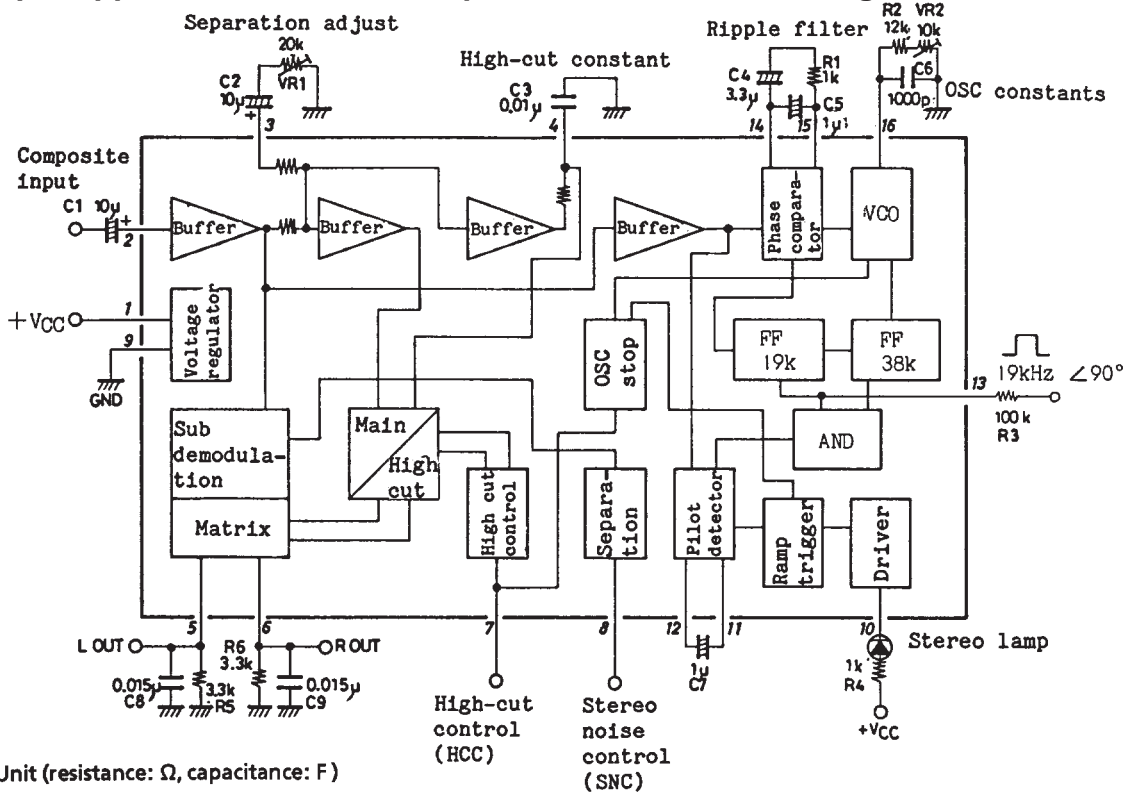

SNC (stereo noise control) and HCC (high-cut control)

The LA3370 has SNC and HCC terminals for improved S/N ratios when operating in weak radio fields. By adjusting the SNC terminal, noises unique to stereo FM in weak fields can be reduced. The HCC terminals permits further improvement of effective S/N ratios by lowering treble levels of FM noises in weak fields. (See Fig.2)

STEREO deteriorates approximately 21.7dB (compared to MONO) in weak radio fields (Fig.2). Generally, when S/N ratios deteriorate below 30 to 40dB, noises become quite noticeable. Section (1) shows ways to set SNC and HCC when radio field strengths are divided into 3 regions, A, B, and C (Fig.2). SNC is expected to function in region A, and HCC in region B. In region C, shallow muting is effected in the IF stage.

(1) SNC (stereo noise control)

Stereo S/N ratios deteriorate 21.7dB below monaural but can be improved by varying stereo separation. S/N improvement becomes apparent, however, only when the separation is 20dB or worse. In that case, the relation between separation and S/N improvement is shown in Fig.3.

SNC in the LA3370 improves S/N ratios in weak radio fields by varying separation. It varies sub-signal demodulation level and controls separation. By using the IF stage signal meter level output as the source of the control signal, S/N ratios in region A of Fig.2 can be maintained at about 40dB or better. Ideal S/N enhancements should provide gradual switching over from stereo to monaural to maintain constant S/N ratios, starting from a point in region A for 40dB stereo S/N toward a point for 40dB monaural S/N. Methods to set the control level will be described later.

Fig.4 shows voltages applied to pin 8 (SNC terminal) of LA3370 versus separation characteristics (SNC characteristics). Pin 8 is also the base of a PNP transistor, so stereo mode is set when pin 8 is open and monaural mode is set when it is grounded. SNC terminal control is effective only when locked with pilot signals and when stereo indicator is lit. External circuit parameters can be chosen in large values that do not affect the IF stage meter output circuit because SNC control currents are small. This makes designing easy. (See Fig.5)

(2) Designing external circuits for SNC characteristics (characteristic setting by drawing)

We recommend the following as a way to adjust SNC characteristics to have smooth transition of separation from stereo monaural in region A of Fig.2.

Separation vs. S/N enhancement relation..... Refer to Fig.3.

SNC pin voltage vs.separation characteristics..... Refer to Fig.4.

Antenna inputs vs. S/N improvement characteristics can be obtained from the drawing if the graph for IF stage signal meter output vs. antenna input and the graph for stereo S/N ratio vs. antenna input are known. From desired S/N characteristics, SNC terminal voltage characteristics can also be obtained. Sample drawings are shown in Fig.6, where for simplicity's sake, SNC, IF meter, and stereo S/N characteristics have been approximated with straight lines.

For instance :

To obtain stereo S/N improvement characteristics from SNC characteristics, when (a) in the second quadrant of the chart represents bare SNC characteristics, point 1 projected to the third quadrant shows a 20dB separation and a 1dB S/N improvement. When projected from the first to the fourth quadrant, a point improved by 1dB in S/N over the stereo S/N line in the fourth quadrant corresponds to point 1. Similarly, point 2 on the SNC characteristics in the second quadrant corresponds to point 2 in the fourth quadrant. Point 3 in the second quadrant corresponds to point 3 in the fourth quadrant. Stereo S/N improvement characteristics for each point are obtainable. Similarly, (b) characteristics in the second quadrant are projected to form (b) characteristics in the fourth quadrant, and (c) in the second quadrant to form (c) in the fourth quadrant, thus providing a way to diagram improvement characteristics.

In the resulting drawings, ideal S/N improvement characteristics are similar to (b) in the fourth quadrant, but corresponding SNC characteristics have to be (b) characteristics in the second quadrant which are difficult to realize. Among realistic characteristics, something like (c) appears to be satisfactory. The (c) SNC characteristics are obtained with a shift by two diodes together with a 1/2 bleeder.

## LA3370



### (3) HCC (high-cut control)

In region B where S/N deteriorates to 40dB or worse even for monaural, the S/N as sensed by the human ear can be enhanced by suppressing levels at frequencies above approximately 7kHz. Treble region levels that follow meter voltages can be smoothly attenuated (high-cut control) by impressing IF stage signal meter output to the HCC pin (pin7) of the LA3370. Fig.7 shows MPX output frequency characteristics (monaural) provided by voltage impressed on pin 7. Frequency characteristics for a 100% high cut can be determined by an external capacitor connected to pin 4. An equivalent circuit is shown below where the designation is made by the 5k $\Omega$  and the C time constant.

Approximate values provided by C as expressed in attenuation at 10kHz are listed in table below : right.

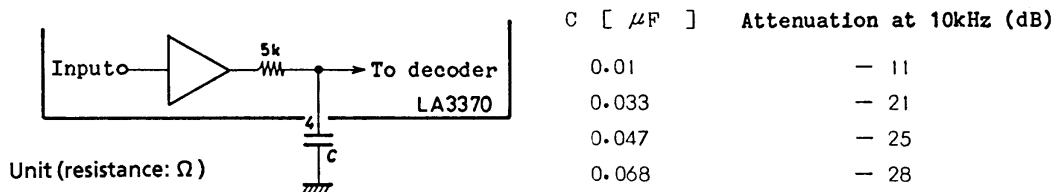
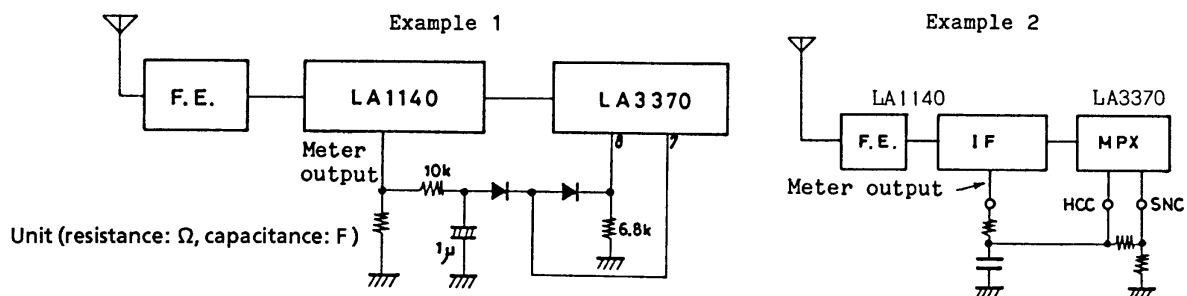

Fig. 8 shows the relation between voltages impressed on pin 7 and rates (%) of high cut (HCC). When IF meter output voltage characteristics and region B, S/N characteristics, of Fig. 2 have been obtained, S/N improvement by HCC can be drawn in a way similar to drawing SNC characteristics.

Fig.2 shows typical meter outputs of a quadrature detection IF amplifier IC. (Fig. 1 shows data for LA1140) HCC characteristics have been designated to permit region B improvements when the IC is directly connected to HCC (pin 7) terminal of the LA3370. The infinitesimal control currents at pin 7, similar to pin 8, do not affect meter outputs.

### (4) SNC and HCC connection circuits when coupled with the IF stage.

Fig. 1 shows sample S/N characteristics via antenna inputs when SNC and HCC are connected with the IF stage by an external circuit.



### (5) S/N improvements in region C of Fig.1

Because S/N ratios deteriorate even further in the region C of Fig. 1, it is better to improve the S/N in this region with IF mutings. The LA1140 is available to linearly vary the IF muting. Employment of the LA3370 together with the LA1140 further enhances S/N improvement.

## LA3370

---

(6) Using the HCC terminal for muting

Muting in the neighborhood of 37dB are feasible by utilizing HCC functions as muting functions when used in home stereos and no need exists to suppress treble noises. Fade-in and fade-out of mutings, permitting delightful, shock-noise-free muting are possible by providing a time constant to the pin 7 control.

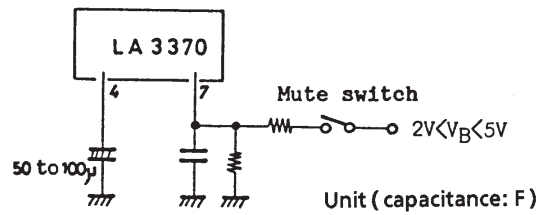

(7) VCO damping

VCO oscillations can be damped by applying a voltage not less than 7V to the HCC terminal (pin 7) to enter a monaural mode. At this time, both SNC and HCC are in an off mode. Fig. 9 shows flow-in current by voltages applied to pin 7.

(8) Separation control terminal

Separation is controlled by controlling the main signal level.

The controllable separation (ratio of sub signal to main signal) range of the input composite signal is approximately as follows :

$$m = \frac{\text{Sub signal level}}{\text{Main signal level}} \quad (\text{at peak level}) \quad 0.7 < m < 1.25$$

(9) For the application of LA1140 + LA3370 and its characteristics, refer to the catalog of the LA1140 (No. EN729).

Sample weak radio field S/N improvements by the system (Fig.1)

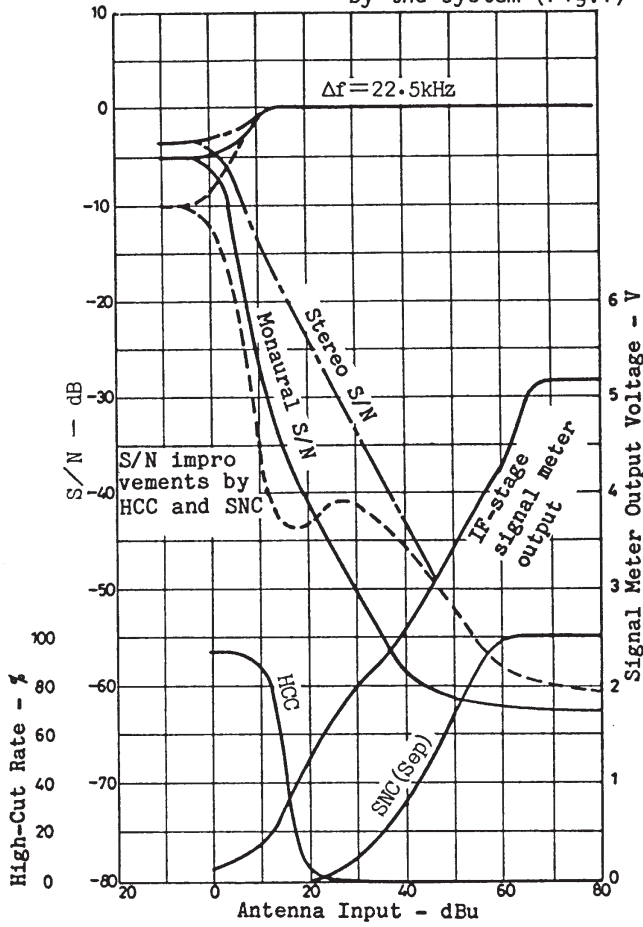

SNC and HCC Operating Regions (Fig.2)

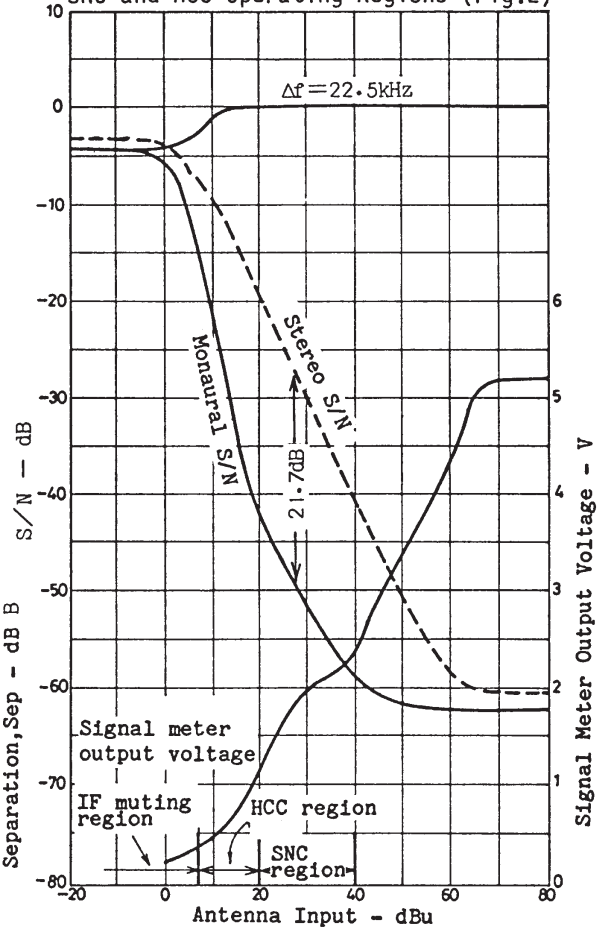

Sep - S/N Improvement (Fig.3)

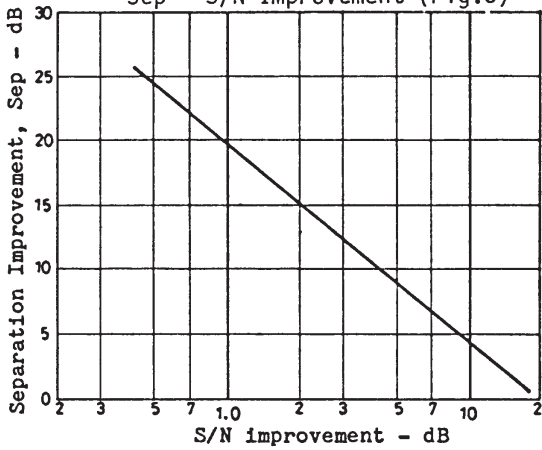

SNC Characteristics (Fig.4a)

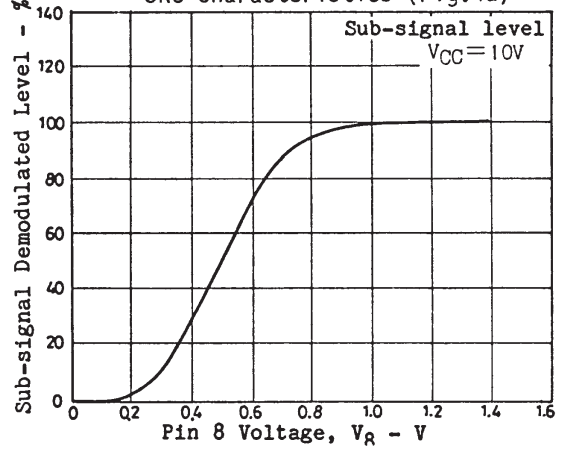

SNC, HCC Control Pin Current (Fig.5)

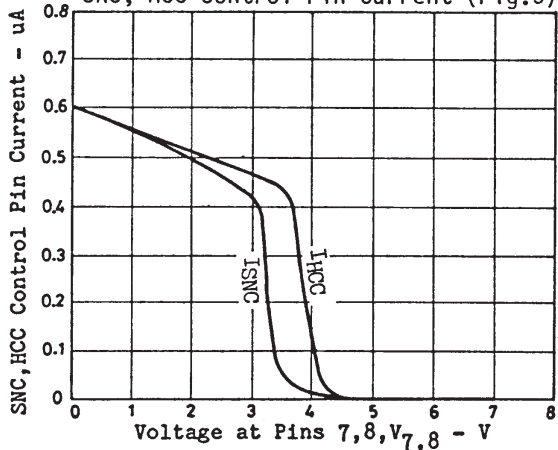

SNC Characteristics (Fig.4b)

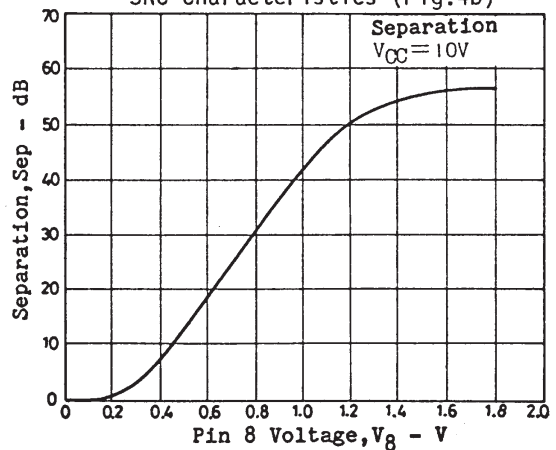
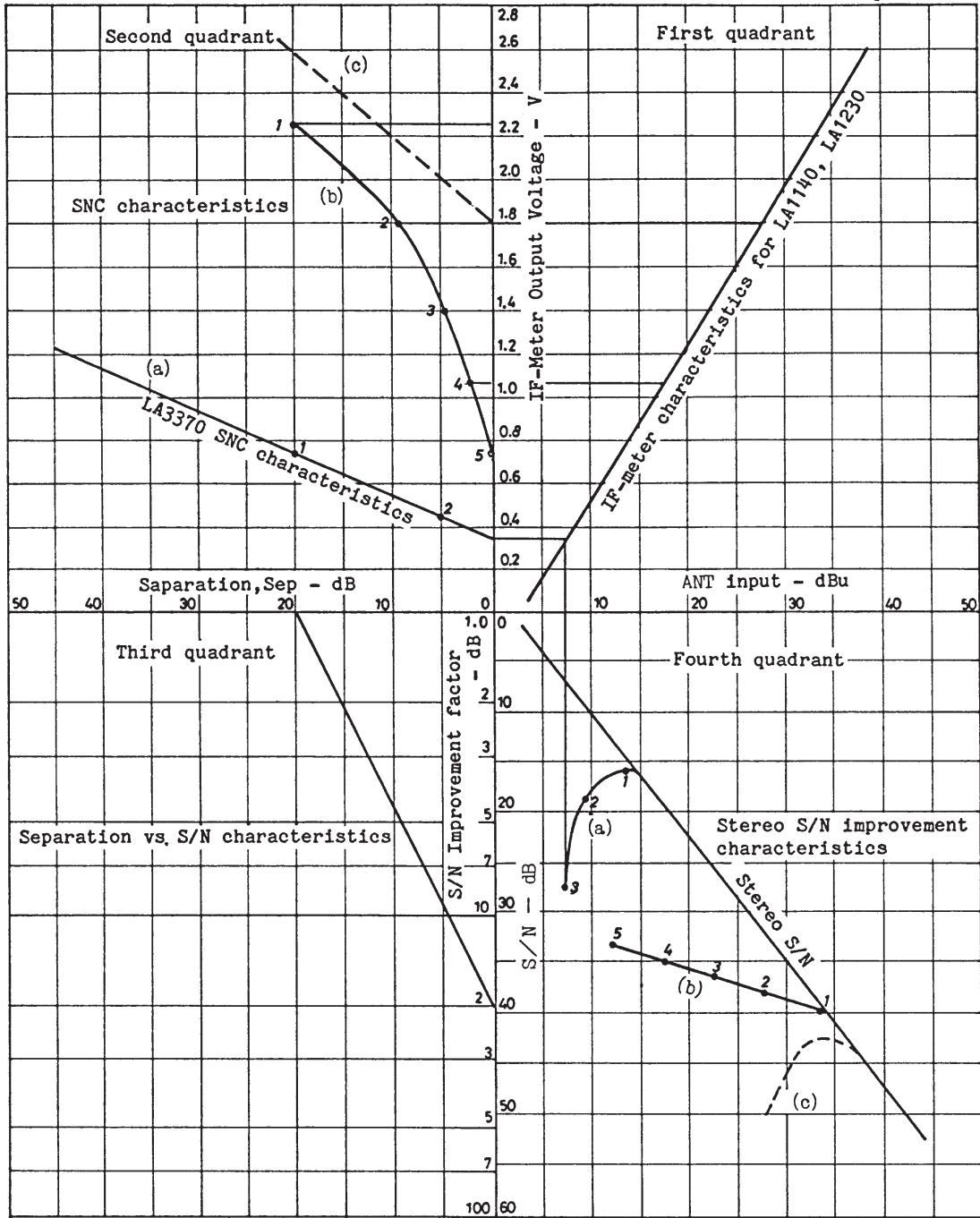
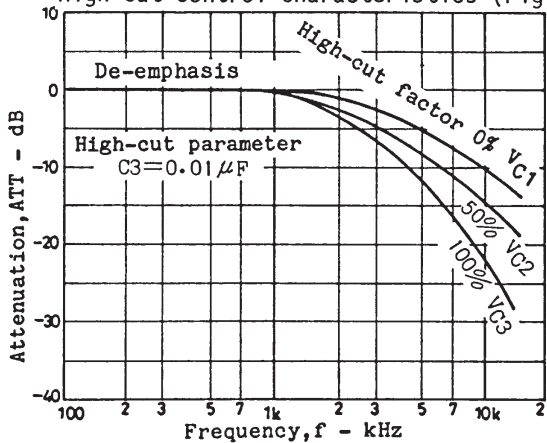

Chart to Obtain Stereo S/N Characteristics from SNC Characteristics (Fig.6)



High-Cut Control Characteristics (Fig.7)



HCC Characteristic (Fig.8)

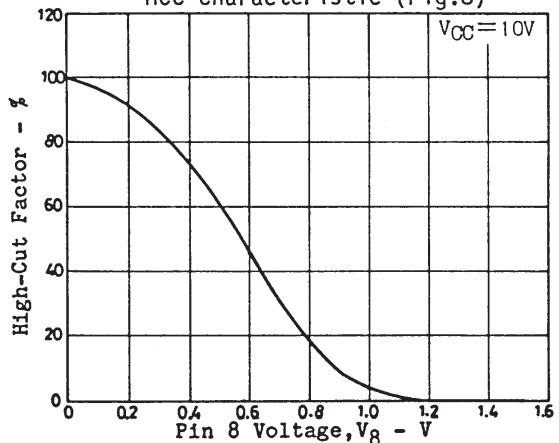



VCO Stop Function Control Terminal Current Characteristics (Fig.9)

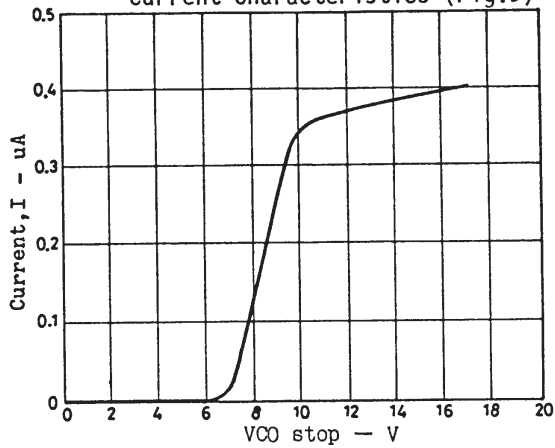

Free-Running Frequency Temperature Characteristic (Fig.10)

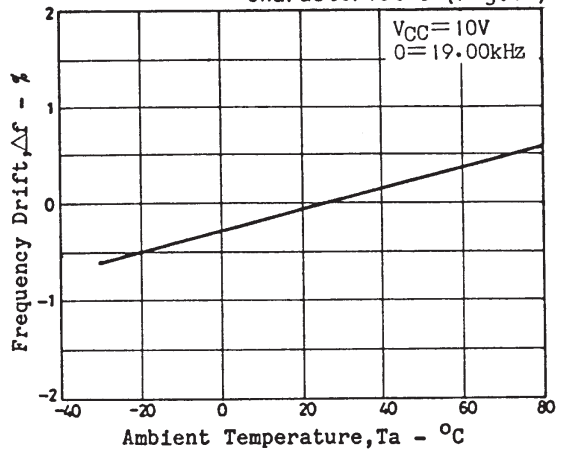

THD - v<sub>i</sub> (Fig 11a)

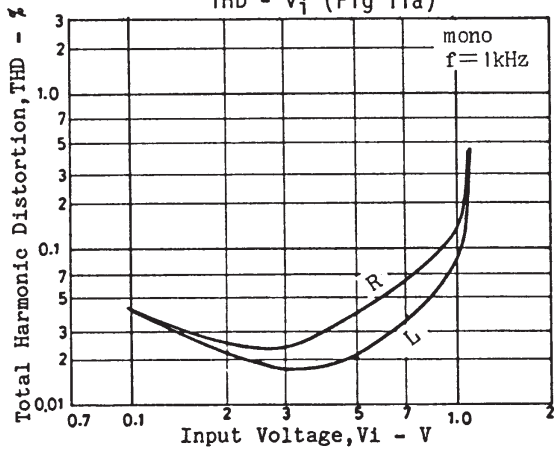

THD - v<sub>i</sub> (Fig 11b)

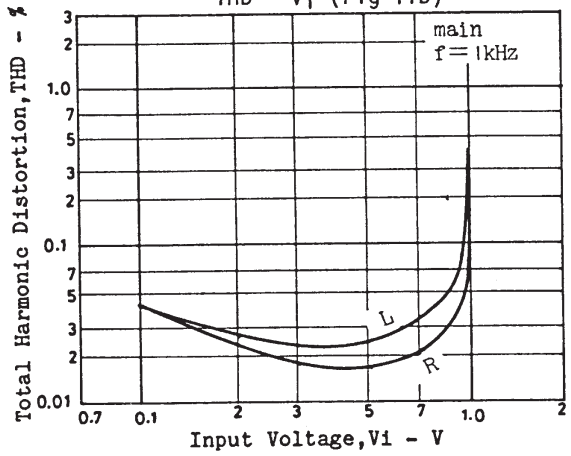

THD - v<sub>i</sub> (Fig 11c)

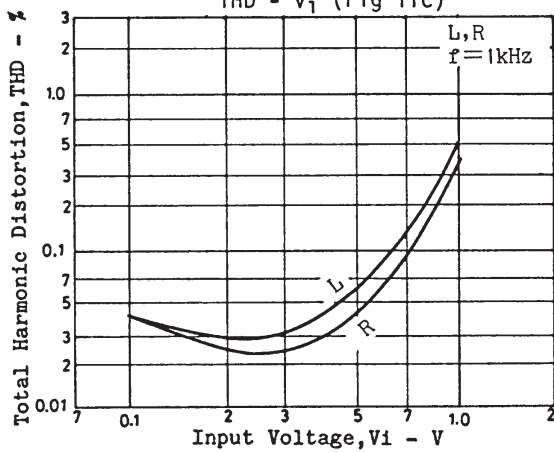

THD - v<sub>i</sub> (Fig 11d)

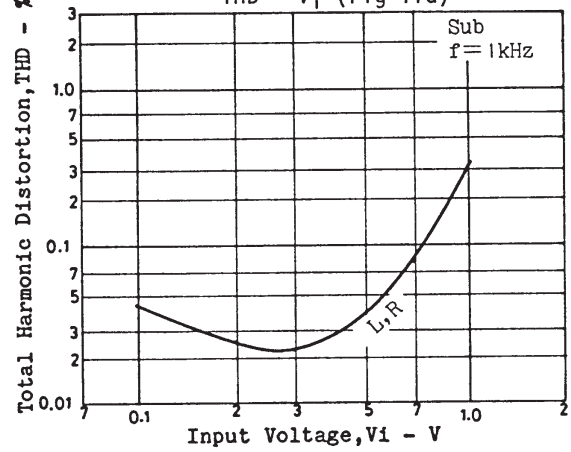

Sep - v<sub>i</sub> (Fig 12)

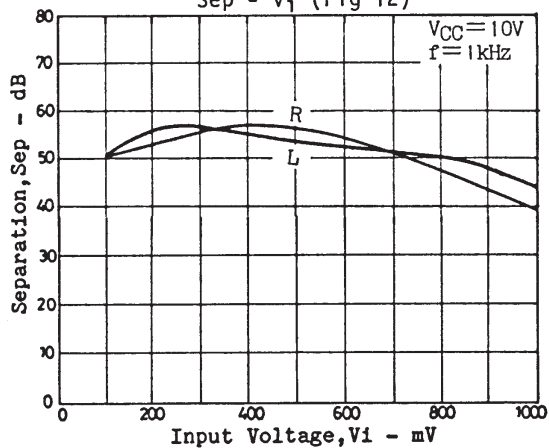

Sep - f (Fig 13)

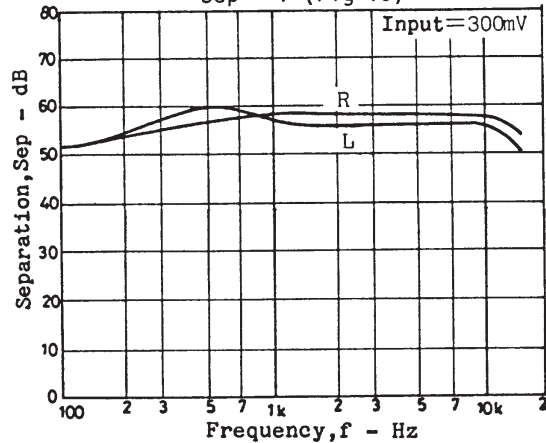

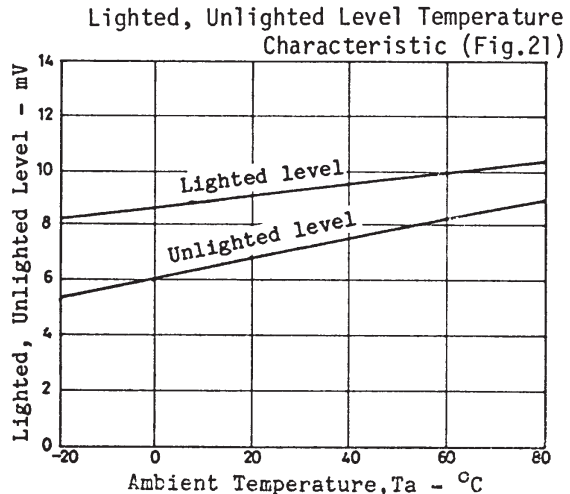
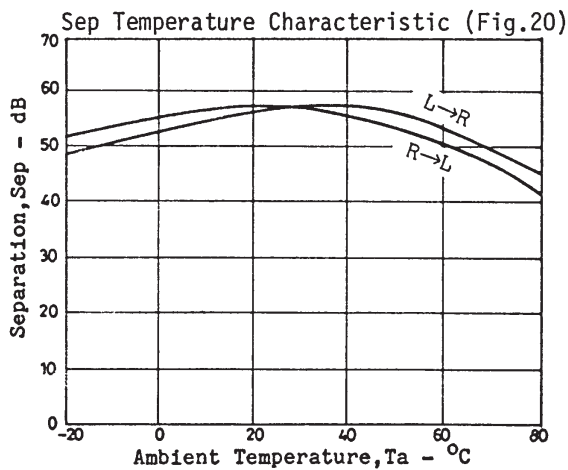
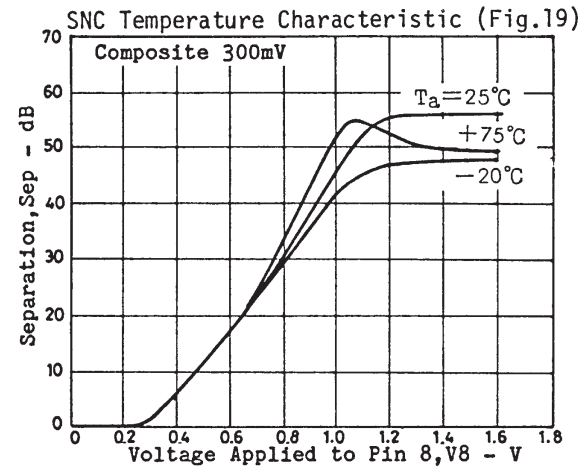
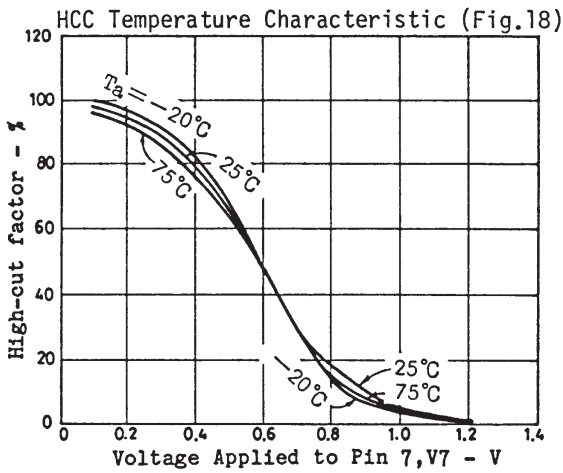
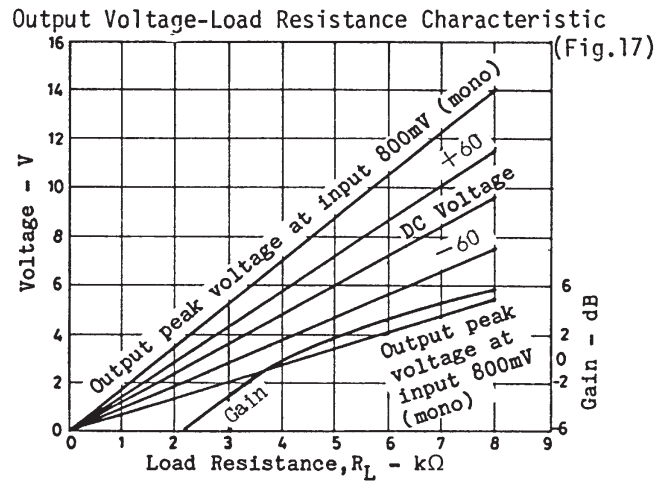
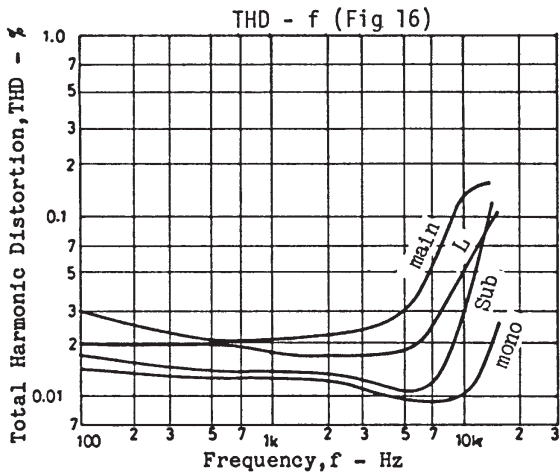
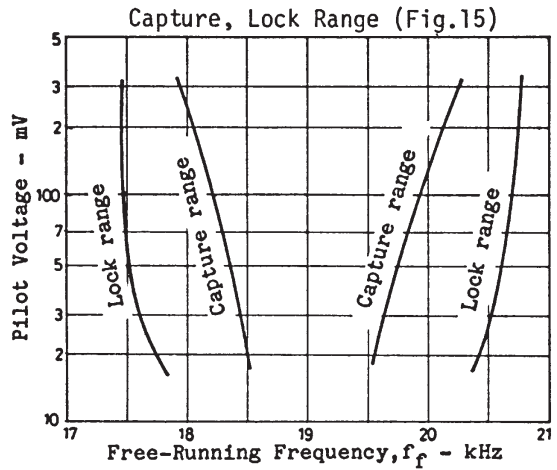
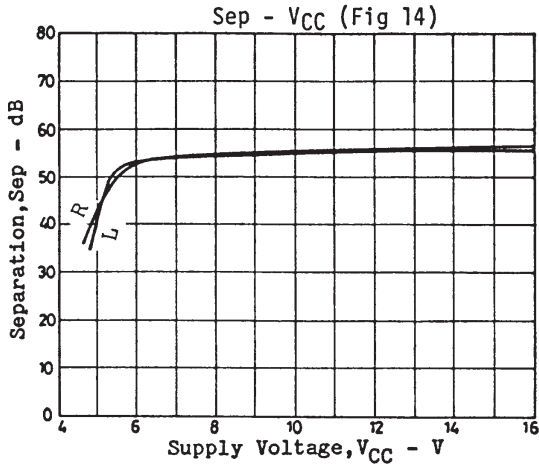

- No products described or contained herein are intended for use in surgical implants, life-support systems, aerospace equipment, nuclear power control systems, vehicles, disaster/crime-prevention equipment and the like, the failure of which may directly or indirectly cause injury, death or property loss.
- Anyone purchasing any products described or contained herein for an above-mentioned use shall:
  - ① Accept full responsibility and indemnify and defend SANYO ELECTRIC CO., LTD., its affiliates, subsidiaries and distributors and all their officers and employees, jointly and severally, against any and all claims and litigation and all damages, cost and expenses associated with such use:
  - ② Not impose any responsibility for any fault or negligence which may be cited in any such claim or litigation on SANYO ELECTRIC CO., LTD., its affiliates, subsidiaries and distributors or any of their officers and employees jointly or severally.
- Information (including circuit diagrams and circuit parameters) herein is for example only; it is not guaranteed for volume production. SANYO believes information herein is accurate and reliable, but no guarantees are made or implied regarding its use or any infringements of intellectual property rights or other rights of third parties.

This catalog provides information as of June, 1997. Specifications and information herein are subject to change without notice.