

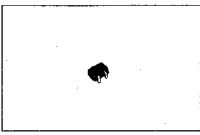

No. 1284

# 2SA1342/2SC3396



**SILICON PNP/NPN EPITAXIAL PLANAR TRANSISTOR  
FOR SWITCHING APPLICATIONS  
(WITH BIAS RESISTOR BUILT IN)**

**Applications**

Switching circuit, inverter, interface circuit, driver

**Features**

- Built-in bias resistor ( $R_1=22k\Omega$ ,  $R_2=22k\Omega$ ).
- Small-sized package (CP).

( ): 2SA1342

**Absolute Maximum Ratings/ $T_a=25^\circ\text{C}$**

			unit
Collector to Base Voltage	$V_{CB0}$	(-)50	V
Collector to Emitter Voltage	$V_{CEO}$	(-)50	V
Emitter to Base Voltage	$V_{EBO}$	(-)10	V
Collector Current	$I_C$	(-)100	mA
Peak Collector Current	$i_{cp}$	(-)200	mA
Collector Dissipation	$P_C$	200	mW
Junction Temperature	$T_j$	150	$^\circ\text{C}$
Storage Temperature	$T_{stg}$	-55 to +150	$^\circ\text{C}$

**Electrical Characteristics/ $T_a=25^\circ\text{C}$**

			min	typ	max	unit
Collector Cutoff Current	$I_{CB0}$	$V_{CB}=(-)40\text{V}$ , $I_E=0$			(-)0.1	$\mu\text{A}$
Collector Cutoff Current	$I_{CEO}$	$V_{CE}=(-)40\text{V}$ , $I_B=0$			(-)0.5	$\mu\text{A}$
Emitter Cutoff Current	$I_{EBO}$	$V_{EB}=(-)5\text{V}$ , $I_C=0$	(-)70	(-)113	(-)150	$\mu\text{A}$
DC Current Gain	$h_{FE}$	$V_{CE}=(-)5\text{V}$ , $I_C=(-)5\text{mA}$	50			
Gain Band-width product	$f_T$	$V_{CE}=(-)10\text{V}$ , $I_C=(-)5\text{mA}$		250 (200)		MHz
Output Capacitance	$c_{ob}$	$V_{CB}=(-)10\text{V}$ , $f=1\text{MHz}$		3.5 (5.3)		pF
Collector to Emitter Saturation Voltage	$V_{CE(sat)}$	$I_C=(-)10\text{mA}$ , $I_B=(-)0.5\text{mA}$	(-)0.1	(-)0.3		V

**Marking on Device**

2SA1342: CL, 2SC3396: CY

**Electrical Connection**

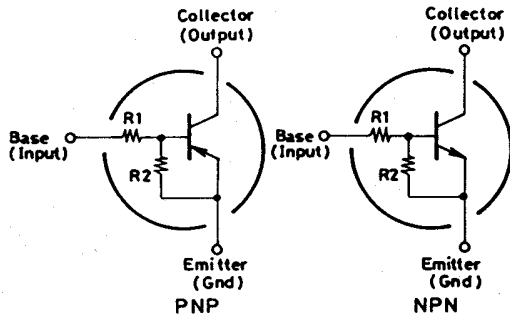

**Case Outline 2018  
(unit: mm)**

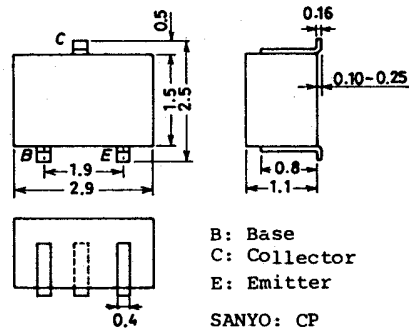

These specifications are subject to change without notice.

			min	typ	max	unit
Collector to Base Breakdown Voltage	$V_{(BR)CBO}$	$I_C=(-)10\mu A, I_E=0$	(-50)			V
Collector to Emitter Breakdown Voltage	$V_{(BR)CEO}$	$I_C=(-)100\mu A, R_{BE}=\infty$	(-50)			V
Input Off Voltage	$V_{I(off)}$	$V_{CE}=(-)5V, I_C=(-)100\mu A$	(-0.8)	(-1.1)	(-1.5)	V
Input On Voltage	$V_{I(on)}$	$V_{CE}=(-)0.2V, I_C=(-)5mA$	(-1.0)	(-1.9)	(-3.0)	V
Input Resistance	$R_1$		15	22	29	k $\Omega$
Input Resistance Ratio	$R_1/R_2$		0.9	1.0	1.1	-

■ Sample Application Circuit

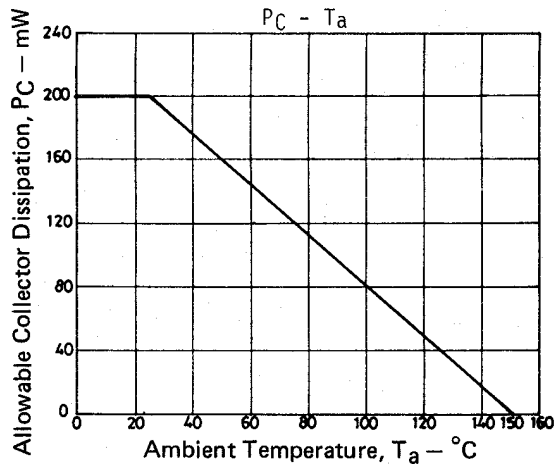
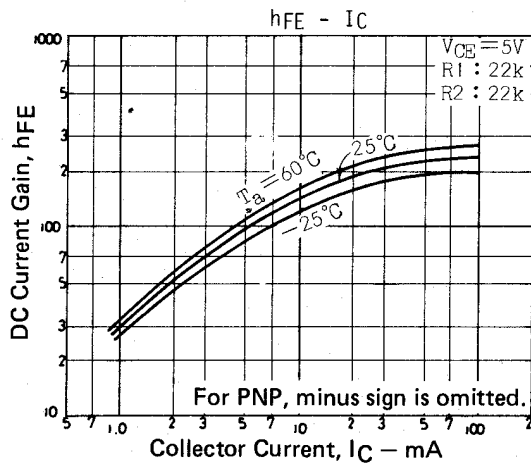
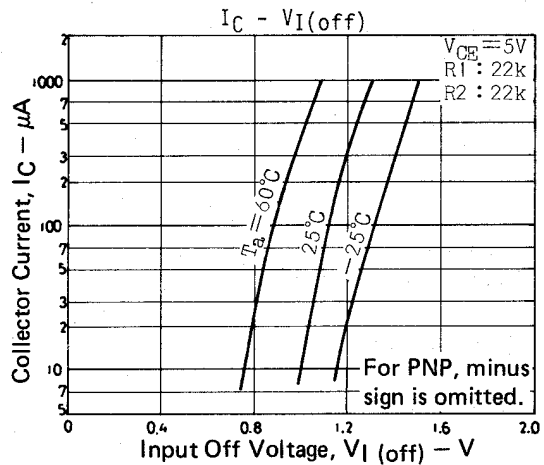
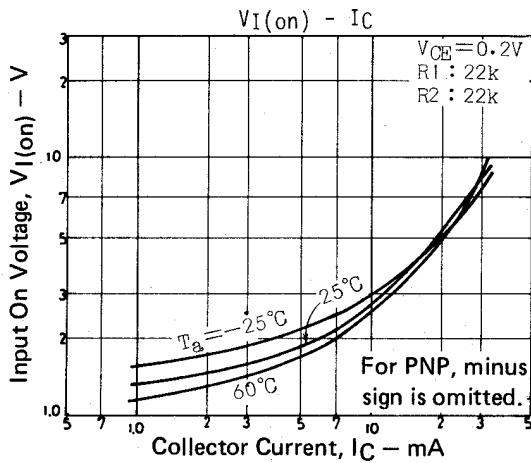
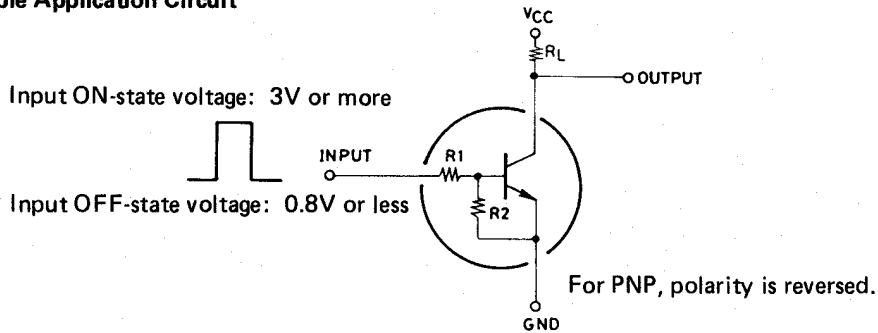

Information furnished by SANYO is believed to be accurate and reliable. However, no responsibility is assumed by SANYO for its use; nor for any infringements of patents or other rights of third parties which may result from its use, and no license is granted by implication or otherwise under any patent or patent rights of SANYO.