

Turbo 2 ultrafast high voltage rectifier

Datasheet – production data

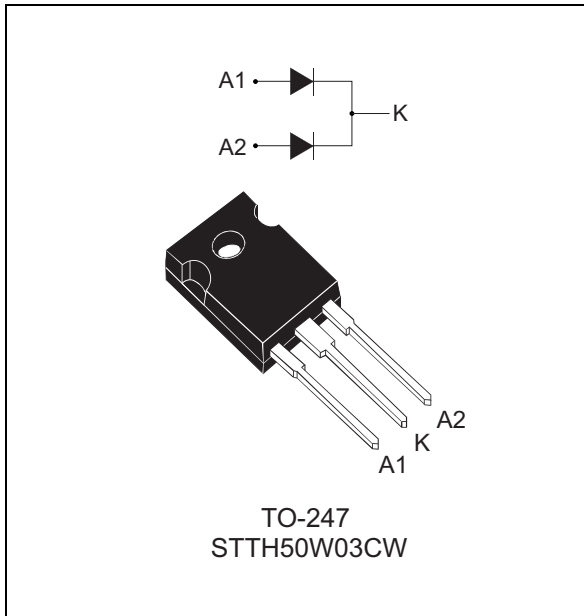

Description

The STTH50W03C uses ST Turbo 2 300 V technology. It is especially suited to be used for DC/DC and DC/AC converters in the secondary stage of MIG/MMA/TIG welding machines. Housed in ST's TO-247, this device offers high power integration for all welding machines and industrial applications.

Table 1. Device summary

| Symbol | Value |
|----------------|----------|
| $I_{F(AV)}$ | 2 x 25 A |
| V_{RRM} | 300 V |
| t_{rr} (typ) | 20 ns |
| T_j | 175 °C |
| V_F (typ) | 1 V |

Features

- Ultrafast switching
- Low reverse recovery current
- Low thermal resistance
- Reduces switching losses
- ECOPACK[®]2 compliant component

1 Characteristics

Table 2. Absolute ratings (limiting values per diode, at 25 °C, unless otherwise specified)

| Symbol | Parameter | | Value | Unit | |
|---------------------|--|-----------------------------------|--------------|------|---|
| V _{RRM} | Repetitive peak reverse voltage | | 300 | V | |
| I _{F(RMS)} | Forward rms current | | 40 | A | |
| I _{F(AV)} | Average forward current, δ = 0.5 | T _c = 105 °C | Per diode | 25 | A |
| | | T _c = 100°C | Per device | 50 | |
| I _{FSM} | Surge non repetitive forward current | t _p = 10 ms sinusoidal | 200 | A | |
| T _{stg} | Storage temperature range | | -65 to + 175 | ° C | |
| T _j | Maximum operating junction temperature | | + 175 | ° C | |

Table 3. Thermal resistance

| Symbol | Parameter | | Value | Unit |
|----------------------|------------------|-----------|-------|--------|
| R _{th(j-c)} | Junction to case | Per diode | 1.8 | °C / W |
| | | Total | 1 | |
| R _{th(c)} | Coupling | | 0.2 | |

When diodes 1 and 2 are used simultaneously:

$$T_{j(\text{diode } 1)} = P_{(\text{diode } 1)} \times R_{th(j-c)}(\text{Per diode}) + P_{(\text{diode } 2)} \times R_{th(c)}$$

Table 4. Static electrical characteristics per diode

| Symbol | Parameter | Test conditions | | Min. | Typ | Max. | Unit |
|-------------------------------|-------------------------|-------------------------|-----------------------------------|------|------|------|------|
| I _R ⁽¹⁾ | Reverse leakage current | T _j = 25 °C | V _R = V _{RRM} | | | 15 | μA |
| | | T _j = 125° C | | | 15 | 150 | |
| V _F ⁽²⁾ | Forward voltage drop | T _j = 25° C | I _F = 25 A | | | 1.5 | V |
| | | T _j = 150° C | | | 1.0 | 1.2 | |
| | | T _j = 25° C | I _F = 50 A | | | 1.8 | |
| | | T _j = 150° C | | | 1.25 | 1.5 | |

1. Pulse test: t_p = 5 ms, δ < 2%

2. Pulse test: t_p = 380 μs, δ < 2%

To evaluate the conduction losses use the following equation:

$$P = 0.9 \times I_{F(AV)} + 0.012 I_{F(RMS)}^2$$

Table 5. Dynamic electrical characteristics per diode

| Symbol | Parameter | Test conditions | | Min. | Typ | Max. | Unit |
|--------------|--------------------------|-----------------------------------|--|------|-----|------|------|
| I_{RM} | Reverse recovery current | $T_j = 125\text{ }^\circ\text{C}$ | $I_F = 25\text{ A}, V_R = 200\text{ V}$ $di_F/dt = -200\text{ A}/\mu\text{s}$ | | 7 | 9 | A |
| Q_{RR} | Reverse recovery charge | | | | 170 | | nC |
| S_{factor} | Softness factor | | | | 0.3 | | |
| t_{rr} | Reverse recovery time | $T_j = 25\text{ }^\circ\text{C}$ | $I_F = 1\text{ A}, V_R = 30\text{ V}$ $di_F/dt = -100\text{ A}/\mu\text{s}$ | | 20 | 27 | ns |
| t_{fr} | Forward recovery time | $T_j = 25\text{ }^\circ\text{C}$ | $I_F = 25\text{ A}, V_{FR} = 1.2\text{ V}$ $di_F/dt = 400\text{ A}/\mu\text{s}$ | | | 120 | ns |
| V_{FP} | Forward recovery voltage | | | | 2.5 | 3.6 | V |

Figure 1. Average forward power dissipation versus average forward current (per diode)

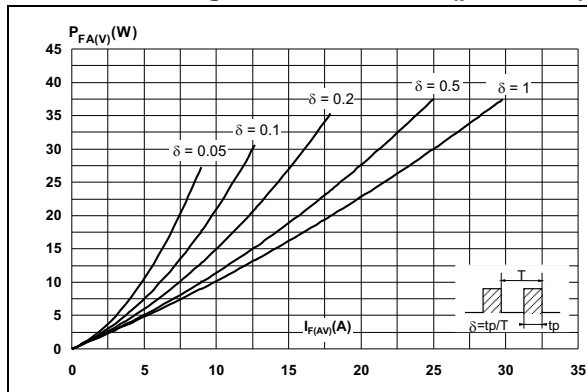

Figure 2. Forward voltage drop versus forward current (typical values, per diode)

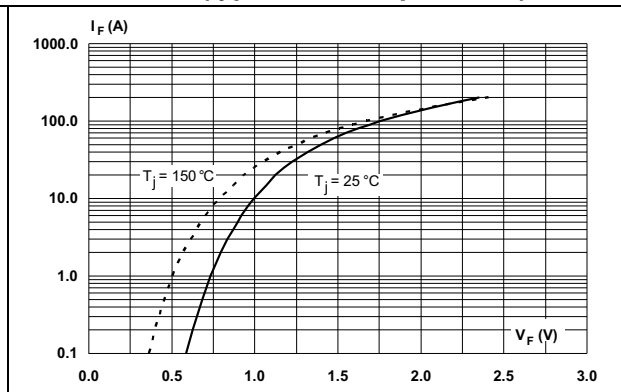

Figure 3. Forward voltage drop versus forward current (maximum values, per diode)

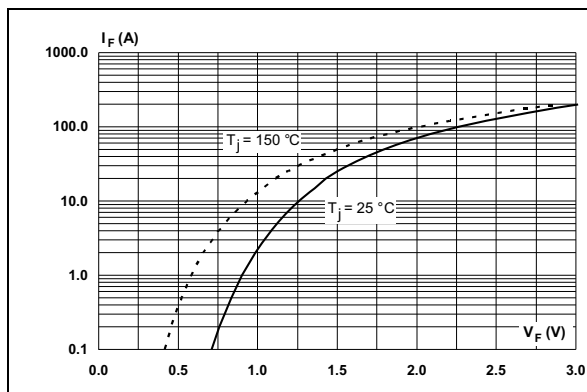

Figure 4. Relative variation of thermal impedance junction to case versus pulse duration

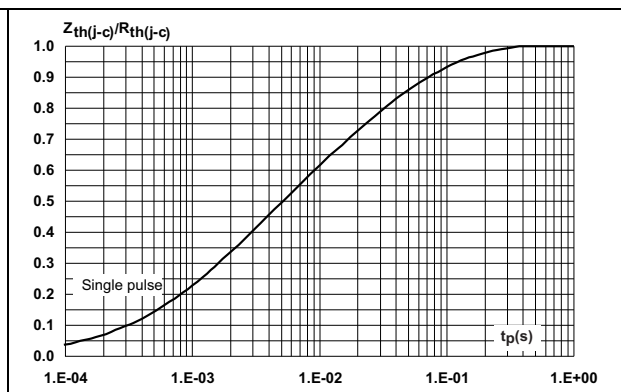

Figure 5. Peak reverse recovery current versus di_F/dt (typical values, per diode)

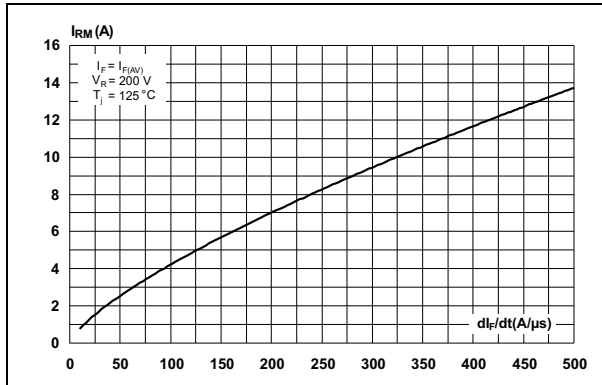

Figure 6. Reverse recovery time versus di_F/dt (typical values, per diode)

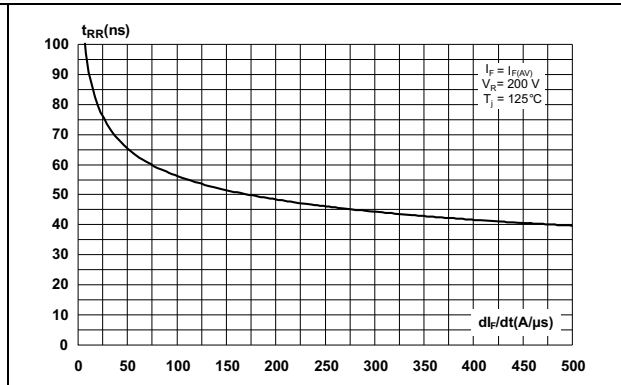

Figure 7. Reverse recovery charges versus di_F/dt (typical values, per diode)

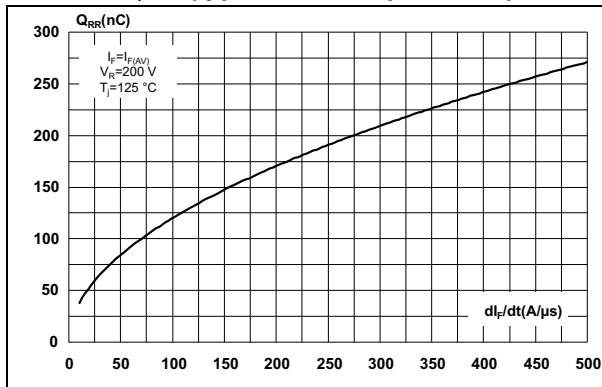

Figure 8. Reverse recovery softness factor versus di_F/dt (typical values, per diode)

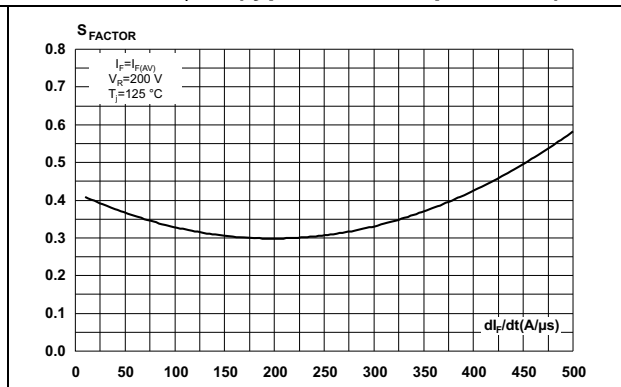

Figure 9. Relative variations of dynamic parameters versus junction temperature

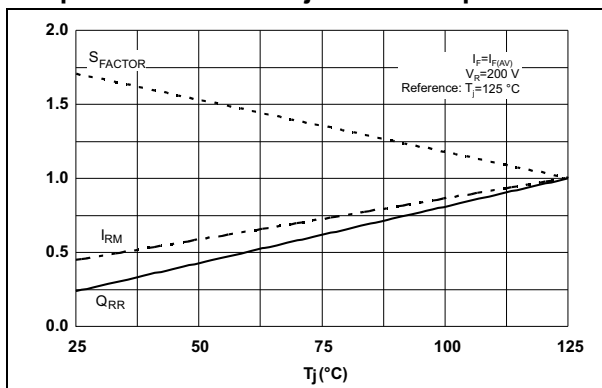

Figure 10. Transient peak forward voltage versus di_F/dt (typical values, per diode)

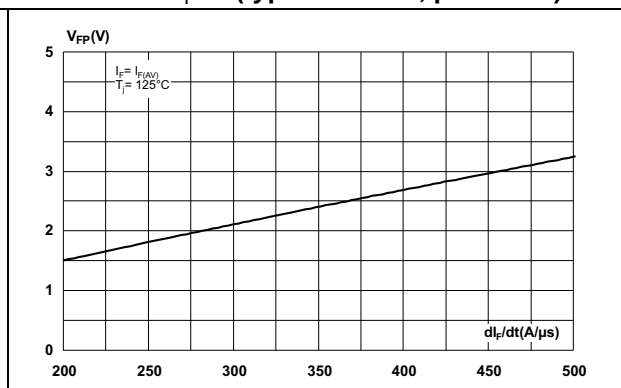

Figure 11. Forward recovery time versus di_F/dt (typical values, per diode)

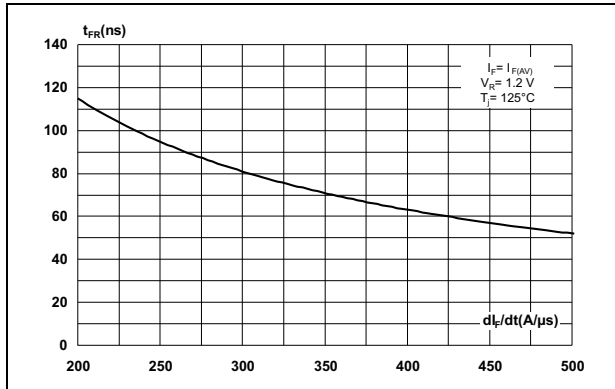
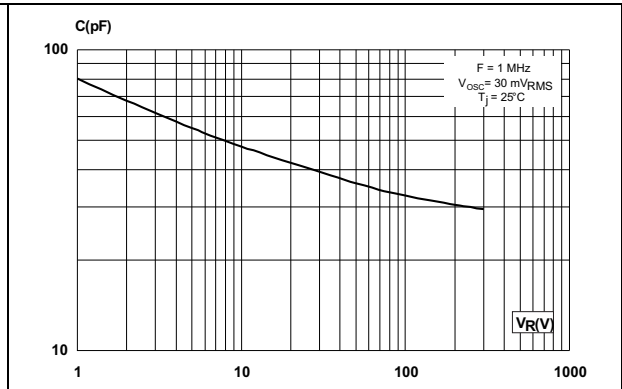

Figure 12. Junction capacitance versus reverse voltage applied (typical values, per diode)



2 Package information

- Epoxy meets UL94, V0
- Cooling method: by conduction (C)
- Recommended torque value: 0.5 N·m
- Maximum torque value: 1.0 N·m

In order to meet environmental requirements, ST offers these devices in different grades of ECOPACK® packages, depending on their level of environmental compliance. ECOPACK® specifications, grade definitions and product status are available at: www.st.com. ECOPACK® is an ST trademark.

Figure 13. TO-247 dimension definitions

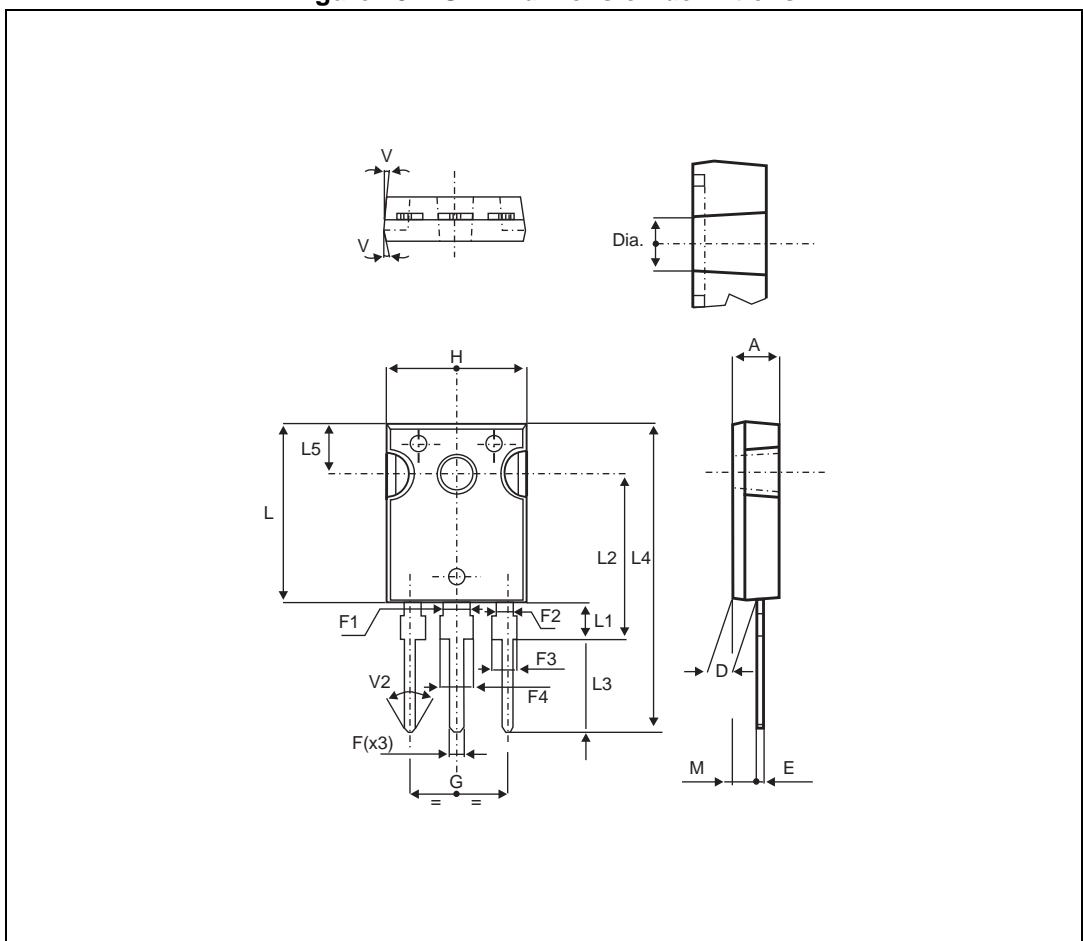

Table 6. TO-247 dimension values

| Ref. | Dimensions | | | | | |
|-------------------|-------------|------|-------|------------|-------|-------|
| | Millimeters | | | Inches | | |
| | Min. | Typ. | Max. | Min. | Typ | Max. |
| A | 4.85 | | 5.15 | 0.191 | | 0.203 |
| A1 | 2.20 | | 2.60 | 0.086 | | 0.102 |
| b | 1.00 | | 1.40 | 0.039 | | 0.055 |
| b1 | 2.00 | | 2.40 | 0.078 | | 0.094 |
| b2 | 3.00 | | 3.40 | 0.118 | | 0.133 |
| c | 0.40 | | 0.80 | 0.015 | | 0.031 |
| D ⁽¹⁾ | 19.85 | | 20.15 | 0.781 | | 0.793 |
| E | 15.45 | | 15.75 | 0.608 | | 0.620 |
| e | 5.30 | 5.45 | 5.60 | 0.209 | 0.215 | 0.220 |
| L | 14.20 | | 14.80 | 0.559 | | 0.582 |
| L1 | 3.70 | | 4.30 | 0.145 | | 0.169 |
| L2 | 18.50 typ. | | | 0.728 typ. | | |
| ∅P ⁽²⁾ | 3.55 | | 3.65 | 0.139 | | 0.143 |
| ∅R | 4.50 | | 5.50 | 0.177 | | 0.217 |
| S | 5.30 | 5.50 | 5.70 | 0.209 | 0.216 | 0.224 |

1. Dimension D plus gate protrusion does not exceed 20.5 mm.
2. Resin thickness around the mounting hole is not less than 0.9 mm.

3 Ordering information

Table 7. Ordering information

| Ordering type | Marking | Package | Weight | Base qty | Delivery mode |
|---------------|-------------|---------|--------|----------|---------------|
| STTH50W03CW | STTH50W03CW | TO-247 | 4.46 g | 50 | Tube |

4 Revision history

Table 8. Document revision history

| Date | Revision | Changes |
|-------------|----------|--------------|
| 09-Aug-2013 | 1 | First issue. |

Please Read Carefully:

Information in this document is provided solely in connection with ST products. STMicroelectronics NV and its subsidiaries ("ST") reserve the right to make changes, corrections, modifications or improvements, to this document, and the products and services described herein at any time, without notice.

All ST products are sold pursuant to ST's terms and conditions of sale.

Purchasers are solely responsible for the choice, selection and use of the ST products and services described herein, and ST assumes no liability whatsoever relating to the choice, selection or use of the ST products and services described herein.

No license, express or implied, by estoppel or otherwise, to any intellectual property rights is granted under this document. If any part of this document refers to any third party products or services it shall not be deemed a license grant by ST for the use of such third party products or services, or any intellectual property contained therein or considered as a warranty covering the use in any manner whatsoever of such third party products or services or any intellectual property contained therein.

UNLESS OTHERWISE SET FORTH IN ST'S TERMS AND CONDITIONS OF SALE ST DISCLAIMS ANY EXPRESS OR IMPLIED WARRANTY WITH RESPECT TO THE USE AND/OR SALE OF ST PRODUCTS INCLUDING WITHOUT LIMITATION IMPLIED WARRANTIES OF MERCHANTABILITY, FITNESS FOR A PARTICULAR PURPOSE (AND THEIR EQUIVALENTS UNDER THE LAWS OF ANY JURISDICTION), OR INFRINGEMENT OF ANY PATENT, COPYRIGHT OR OTHER INTELLECTUAL PROPERTY RIGHT.

ST PRODUCTS ARE NOT AUTHORIZED FOR USE IN WEAPONS. NOR ARE ST PRODUCTS DESIGNED OR AUTHORIZED FOR USE IN: (A) SAFETY CRITICAL APPLICATIONS SUCH AS LIFE SUPPORTING, ACTIVE IMPLANTED DEVICES OR SYSTEMS WITH PRODUCT FUNCTIONAL SAFETY REQUIREMENTS; (B) AERONAUTIC APPLICATIONS; (C) AUTOMOTIVE APPLICATIONS OR ENVIRONMENTS, AND/OR (D) AEROSPACE APPLICATIONS OR ENVIRONMENTS. WHERE ST PRODUCTS ARE NOT DESIGNED FOR SUCH USE, THE PURCHASER SHALL USE PRODUCTS AT PURCHASER'S SOLE RISK, EVEN IF ST HAS BEEN INFORMED IN WRITING OF SUCH USAGE, UNLESS A PRODUCT IS EXPRESSLY DESIGNATED BY ST AS BEING INTENDED FOR "AUTOMOTIVE, AUTOMOTIVE SAFETY OR MEDICAL" INDUSTRY DOMAINS ACCORDING TO ST PRODUCT DESIGN SPECIFICATIONS. PRODUCTS FORMALLY ESCC, QML OR JAN QUALIFIED ARE DEEMED SUITABLE FOR USE IN AEROSPACE BY THE CORRESPONDING GOVERNMENTAL AGENCY.

Resale of ST products with provisions different from the statements and/or technical features set forth in this document shall immediately void any warranty granted by ST for the ST product or service described herein and shall not create or extend in any manner whatsoever, any liability of ST.

ST and the ST logo are trademarks or registered trademarks of ST in various countries.

Information in this document supersedes and replaces all information previously supplied.

The ST logo is a registered trademark of STMicroelectronics. All other names are the property of their respective owners.

© 2013 STMicroelectronics - All rights reserved

STMicroelectronics group of companies

Australia - Belgium - Brazil - Canada - China - Czech Republic - Finland - France - Germany - Hong Kong - India - Israel - Italy - Japan - Malaysia - Malta - Morocco - Philippines - Singapore - Spain - Sweden - Switzerland - United Kingdom - United States of America

www.st.com



Mouser Electronics

Authorized Distributor

Click to View Pricing, Inventory, Delivery & Lifecycle Information:

[STMicroelectronics:](#)

[STTH50W03CW](#)