

**28W Hi-Fi AUDIO POWER AMPLIFIER
WITH MUTE / STAND-BY**

- SUPPLY VOLTAGE RANGE UP TO $\pm 22V$
- SPLIT SUPPLY OPERATION
- HIGH OUTPUT POWER
(UP TO 28W MUSIC POWER)
- LOW DISTORTION
- MUTE/STAND-BY FUNCTION
- NO SWITCH ON/OFF NOISE
- AC SHORT CIRCUIT PROTECTION
- THERMAL SHUTDOWN
- ESD PROTECTION

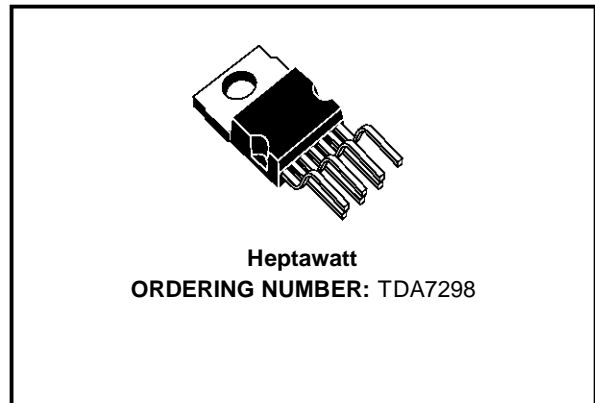

DESCRIPTION

The TDA7298 is a monolithic integrated circuit in Heptawatt package, intended for use as audio class AB amplifier in TV or Hi-Fi field application. Thanks to the wide voltage range and to the high out current capability it's able to supply the high-

est power into both 4 Ω and 8 Ω loads even in presence of poor supply regulation.

The built in Muting/Stand-by function simplifies the remote operations avoiding also switching on-off noises.

TEST AND APPLICATION CIRCUIT

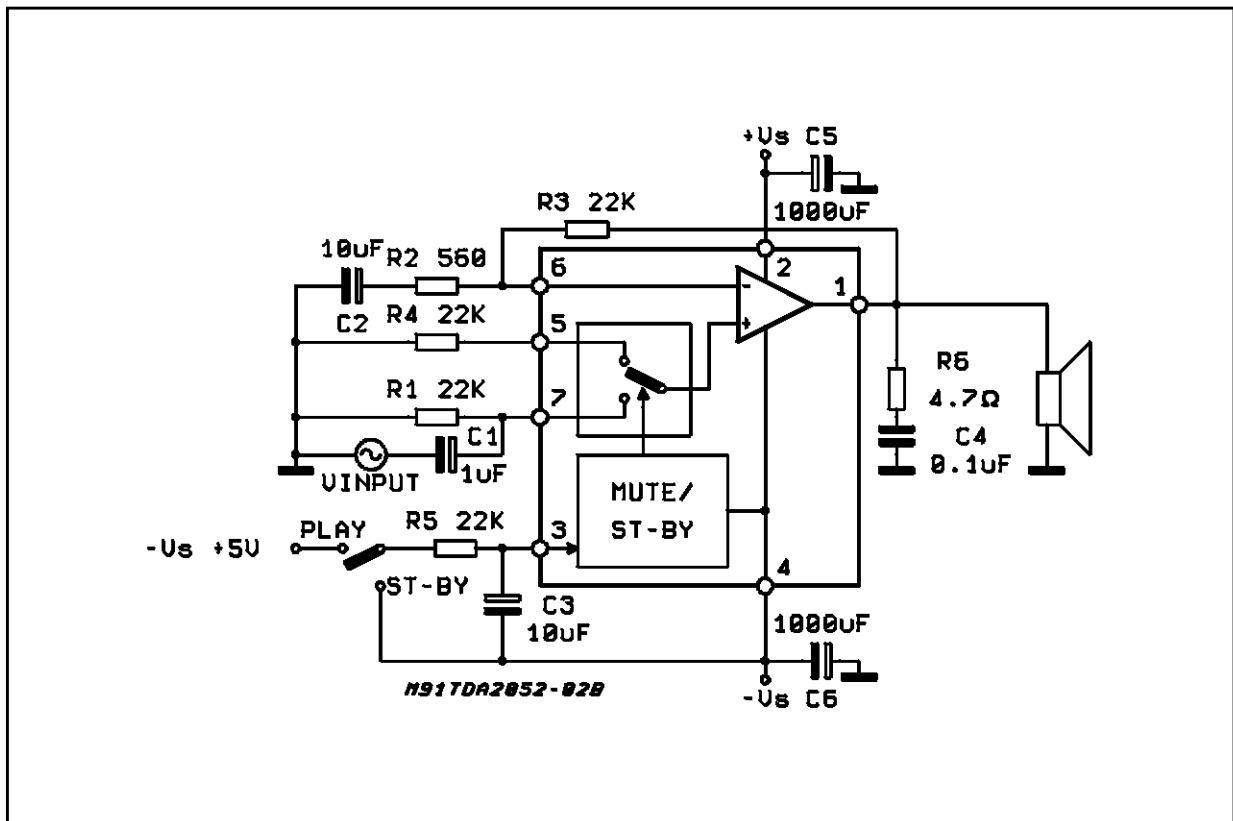

TDA7298

ABSOLUTE MAXIMUM RATINGS

Symbol	Parameter	Value	Unit
V_S	DC Supply Voltage	± 22	V
I_O	Output Peak Current (internally limited)	4	A
P_{tot}	Power Dissipation $T_{case} = 70^\circ\text{C}$	30	W
T_{op}	Operating Temperature Range	0 to $+70$	$^\circ\text{C}$
T_{stg}, T_j	Storage and Junction Temperature	-40 to $+150$	$^\circ\text{C}$

PIN CONNECTION (Top view)

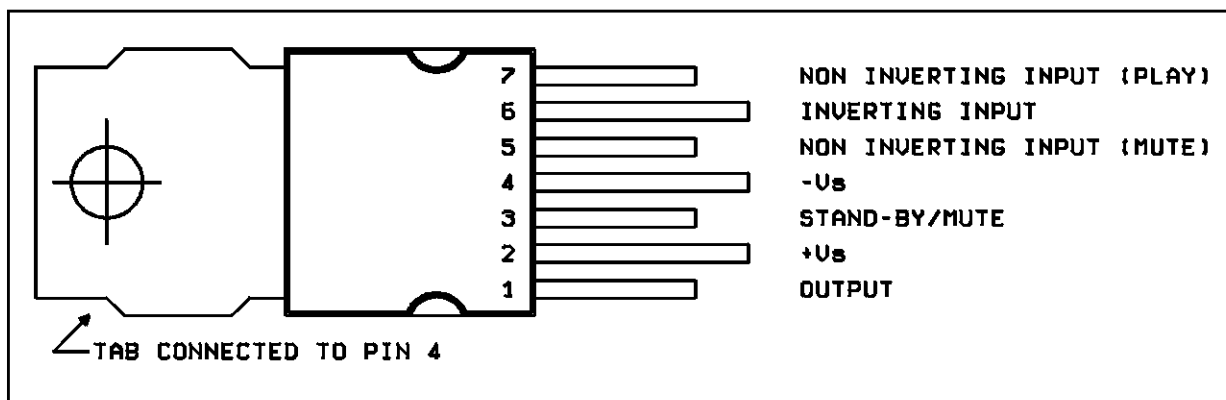

BLOCK DIAGRAM

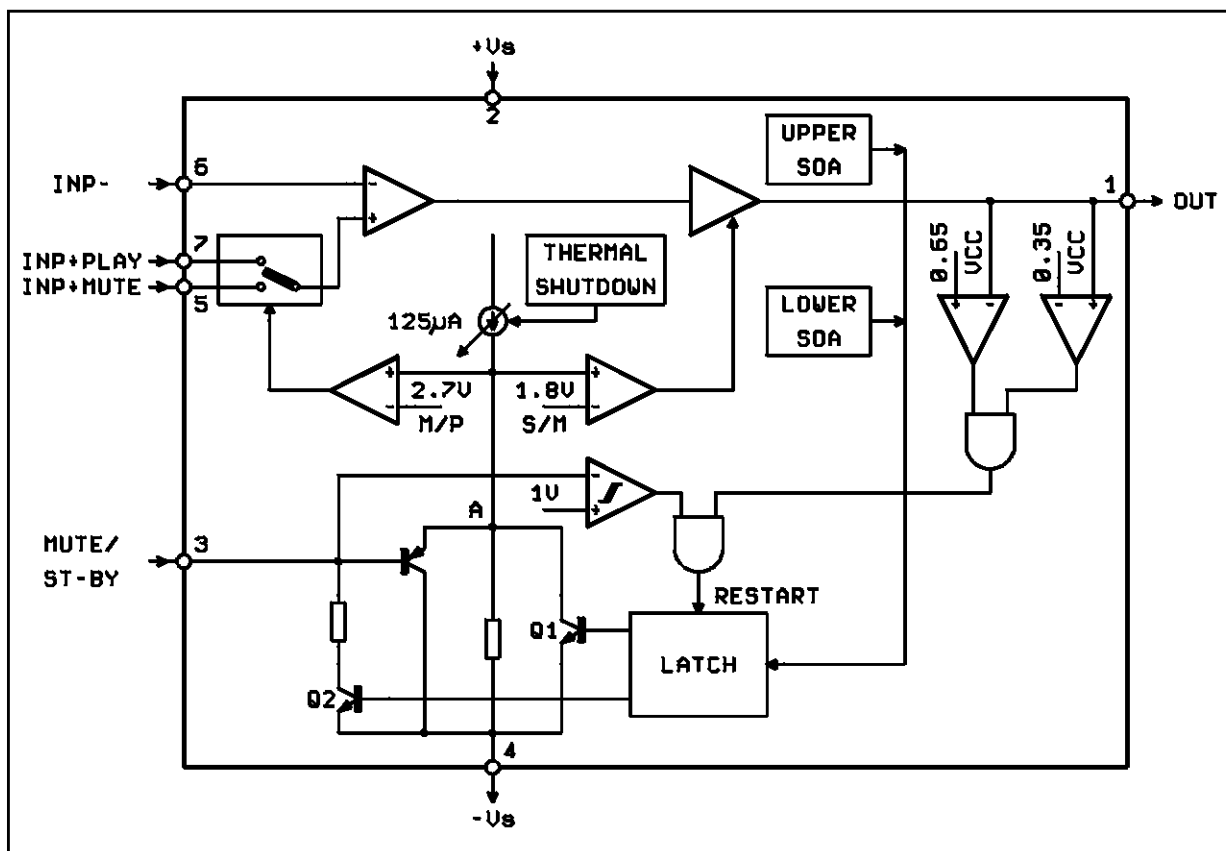

THERMAL DATA

Symbol	Description	Value	Unit
$R_{th\ j-case}$	Thermal Resistance Junction-case	Max 2.5	°C/W

ELECTRICAL CHARACTERISTICS (Refer to the test circuit, $G_V = 32dB$; $V_S \pm 18V$; $f = 1KHz$; $T_{amb} = 25^\circ C$, unless otherwise specified.)

Symbol	Parameter	Test Condition	Min.	Typ.	Max.	Unit
V_S	Supply Range		± 6		± 22	V
I_q	Total Quiescent Current	$V_S = \pm 22V$	20	40	70	mA
I_b	Input Bias Current				± 0.5	μA
V_{OS}	Input Offset Voltage				± 15	mV
I_{OS}	Input Offset Current				± 200	nA
P_O	Music Output Power IEC268-3 Rules (*)		$V_S = \pm 20, R_L = 8\Omega,$ $d = 10\%, t = 1s$		28	
P_O	Output Power (continuous RMS)	$d = 10\%$ $R_L = 4\Omega \quad V_S = \pm 14V$ $R_L = 8\Omega$	20 20	24 24		W W
		$d = 1\%$ $R_L = 4\Omega \quad V_S = \pm 14V$ $R_L = 8\Omega$		17 17		W W
d	Total Harmonic Distortion	$R_L = 4\Omega \quad V_S = \pm 14V$ $P_O = 0.1$ to 10W; $f = 100Hz$ to 15KHz		0.1	0.7	%
		$R_L = 8\Omega$ $P_O = 0.1$ to 10W; $f = 100Hz$ to 15KHz		0.1	0.5	%
SR	Slew Rate		3	5		V/ μs
G_V	Open Loop Voltage Gain			80		dB
e_N	Total Input Noise	A Curve $f = 20Hz$ to 20KHz		2 3	10	μV μV
R_i	Input Resistance		500			K Ω
SVR	Supply Voltage Rejection	$f = 100Hz, V_{ripple} = 1V_{RMS}$	40	50		dB
T_S	Thermal Shutdown			145		°C

MUTE/STAND-BY FUNCTION (Ref. $-V_S$)

V_{TST-BY}	Stand-by - Threshold		1	1.8		V
V_{TPLAY}	Play Threshold			2.7	4	V
$I_{q\ ST-BY}$	Quiescent Current @ Stand-by	$V_{pin\ 3} = 0.5V$		1	3	mA
ATT_{ST-BY}	Stand-by Attenuation		70	90		dB
I_{pin3}	Pin 3 Current @ Stand-by			-1	± 10	μA

Note (*):**MUSIC POWER CONCEPT**

MUSIC POWER is (according to the IEC clauses n.268-3 of Jan 83) the maximal power which the amplifier is capable of producing across the rated load resistance (regardless of non linearity) 1 sec after the application of a sinusoidal input signal of frequency 1KHz.

According to this definition our method of measurement comprises the following steps:

- 1) Set the voltage supply at the maximum operating value -10%
- 2) Apply a input signal in the form of a 1KHz tone burst of 1 sec duration; the repetition period of the signal pulses is > 60 sec
- 3) The output voltage is measured 1 sec from the start of the pulse
- 4) Increase the input voltage until the output signal show a THD = 10%
- 5) The music power is then V_{out}^2/R_1 , where V_{out} is the output voltage measured in the condition of point 4) and R_1 is the rated load impedance

The target of this method is to avoid excessive dissipation in the amplifier.

APPLICATIONS SUGGESTIONS (See Test and Application Circuit)

The recommended values of the external components are those shown on the application circuit. Different values can be used; the following table can help the designer.

Comp.	Value	Purpose	Larger Than	Smaller Than
R1	22KΩ (*)	Input Impedance	Increase of Input Impedance	Decrease of Input Impedance
R2	560Ω	Closed Loop Gain set to 32dB (**)	Decrease of Gain	Increase of Gain
R3	22KΩ (*)		Increase of Gain	Decrease of Gain
R4	22KΩ (*)	Input Impedance @ Mute		
R5	22KΩ	Stand-by Time Constant		
R6	4.7Ω	Frequency Stability	Danger of oscillations	Danger of oscillations
C1	1μF	Input DC Decoupling		Higher Low-frequency cut-off
C2	10μF	Feedback DC Decoupling		Higher Low-frequency cut-off
C3	10μF	Stand-by Time Constant		
C4	0.100μF	Frequency Stability		Danger of Oscillations
C5, C6	1000μF	Supply Voltage Bypass		

(*) R1 = R3 = R4 for POP optimization

(**) Closed Loop Gain has to be ≥ 30 dB

TYPICAL CHARACTERISTICS

Figure 1: Output Power vs. Supply Voltage

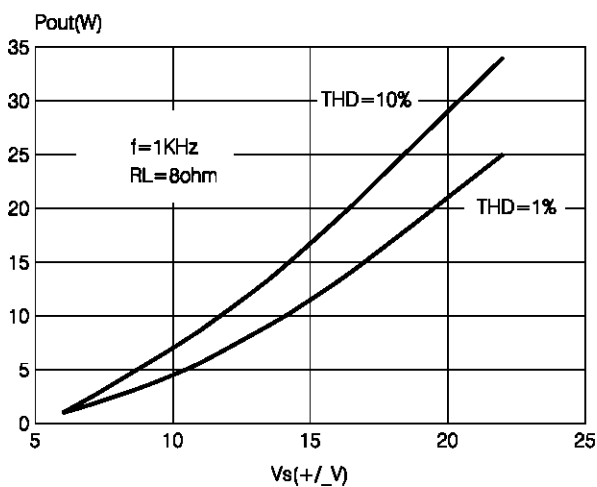

Figure 2: Distortion vs. Output Power

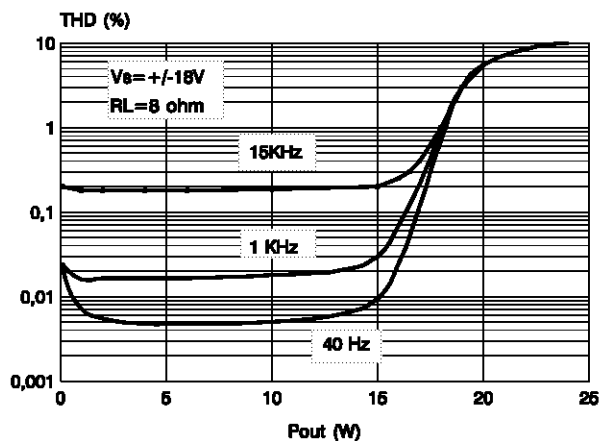

Figure 3: Output Power vs. Supply Voltage.

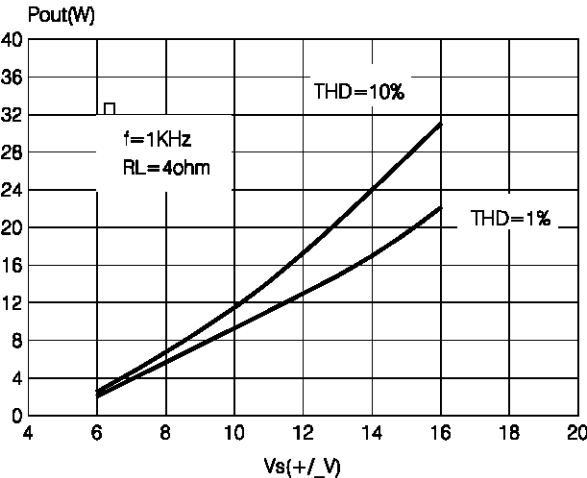

Figure 4: Distortion vs. Output Power.

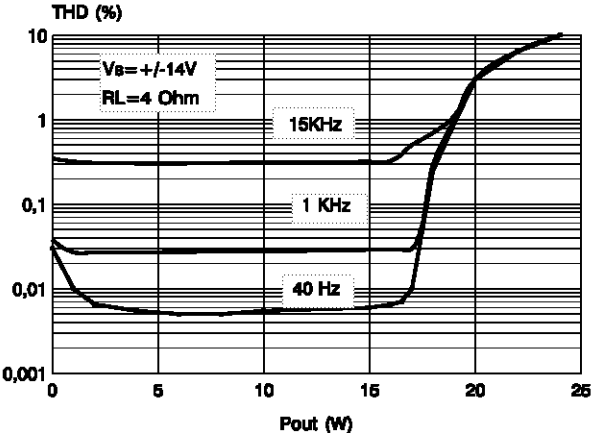

Figure 5: Distortion vs. Frequency.

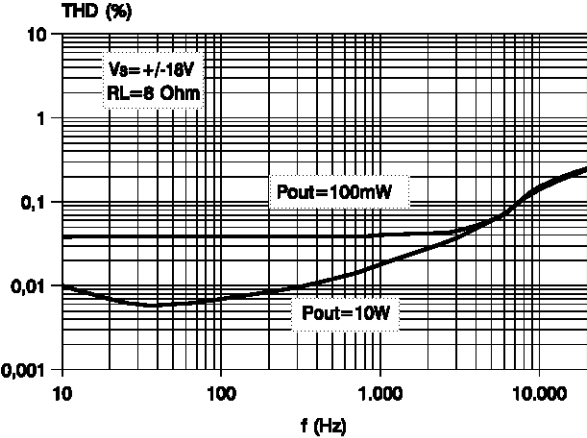

Figure 6: Distortion vs. Frequency.

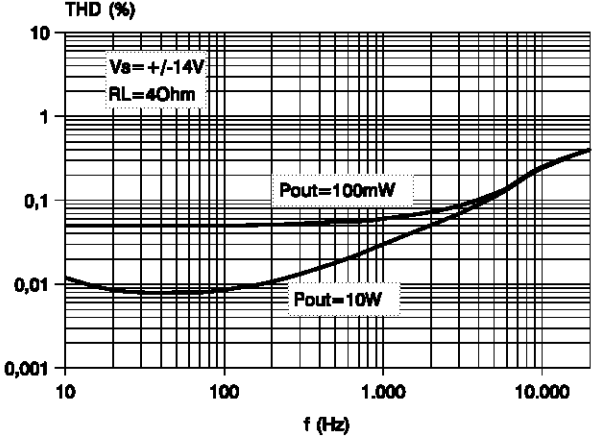

Figure 7: Quiescent Current vs. Supply Voltage

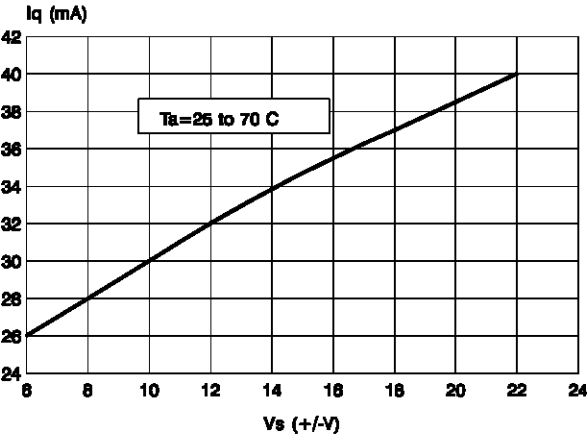

Figure 8: Supply Voltage Rejection vs. Frequency.

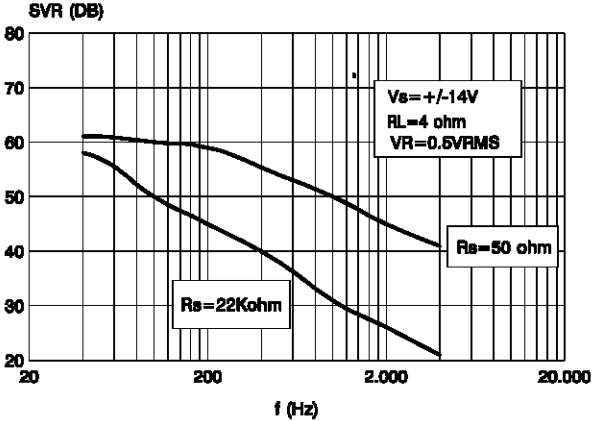

Figure 9: Bandwidth.

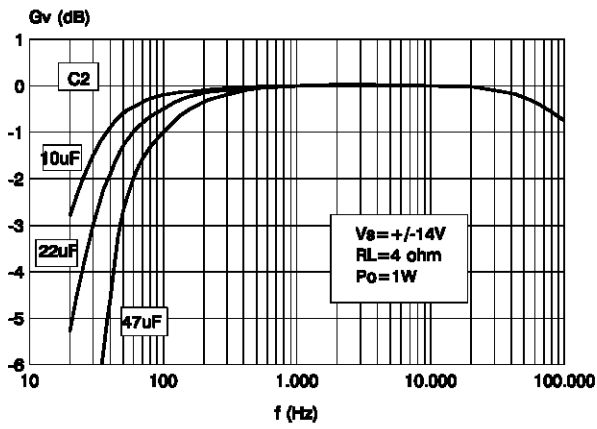

Figure 10: Output Attenuation & Quiescent Current vs. V_{pin3} .

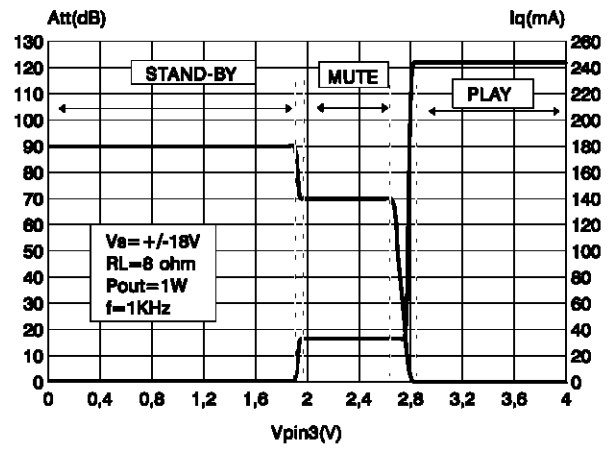

Figure 11: Total Power Dissipation & Efficiency vs. Output Power.

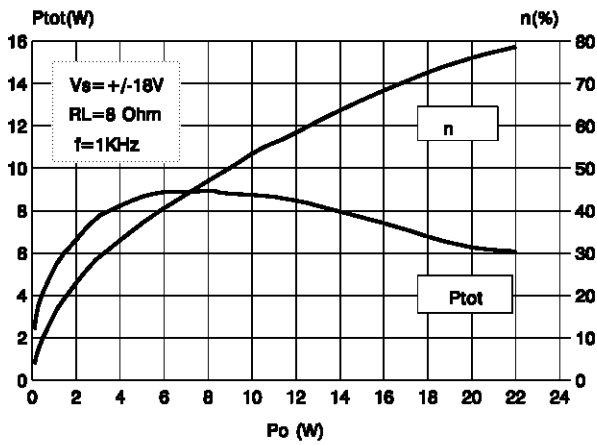

Figure 12: Total Power Dissipation & Efficiency vs. Output Power.

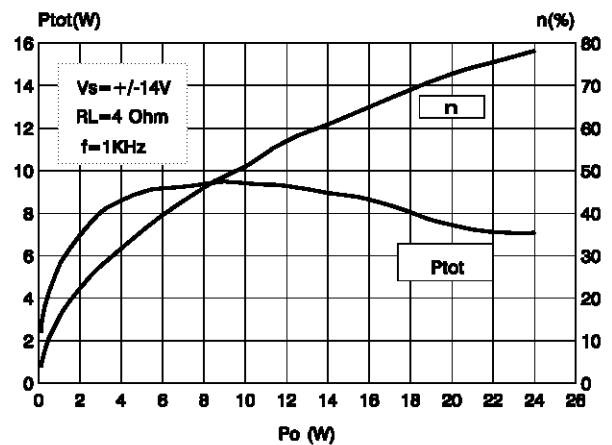

Figure 13: P.C. Board and Components Layout of the Circuit of Fig. 14 (1:1 scale)

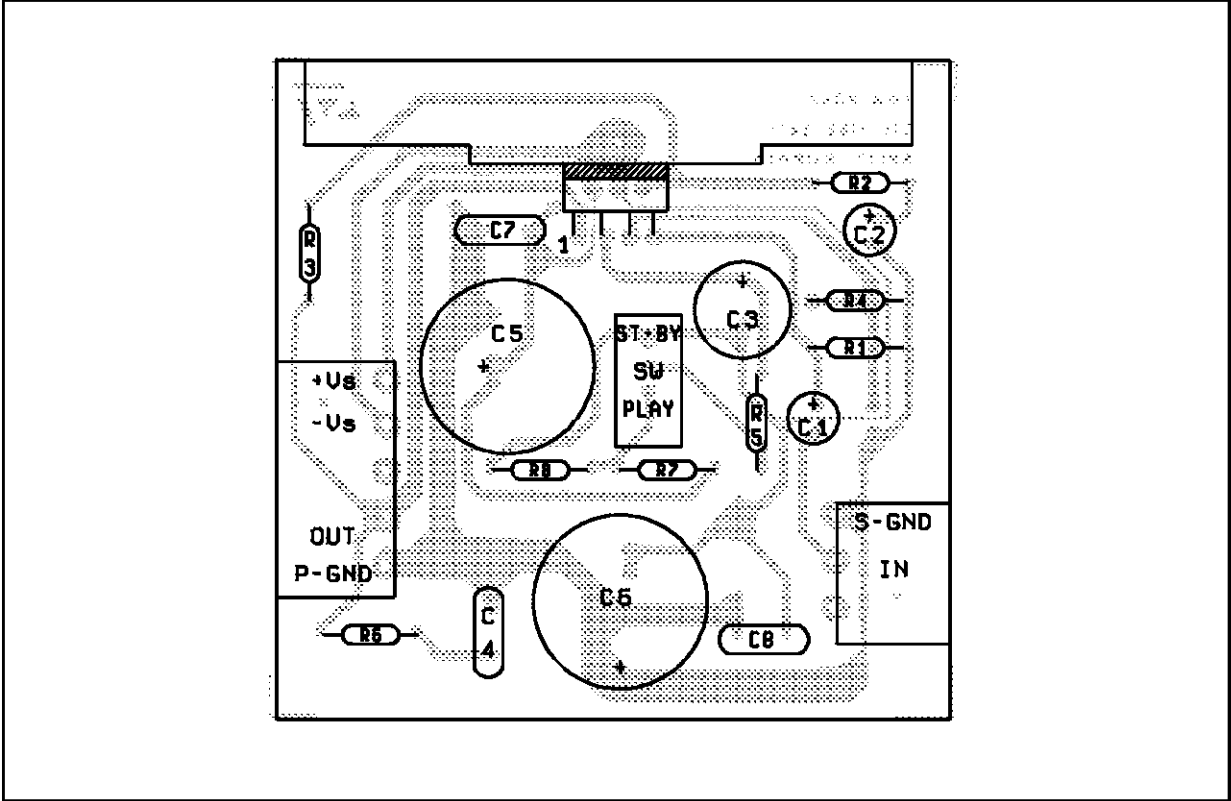
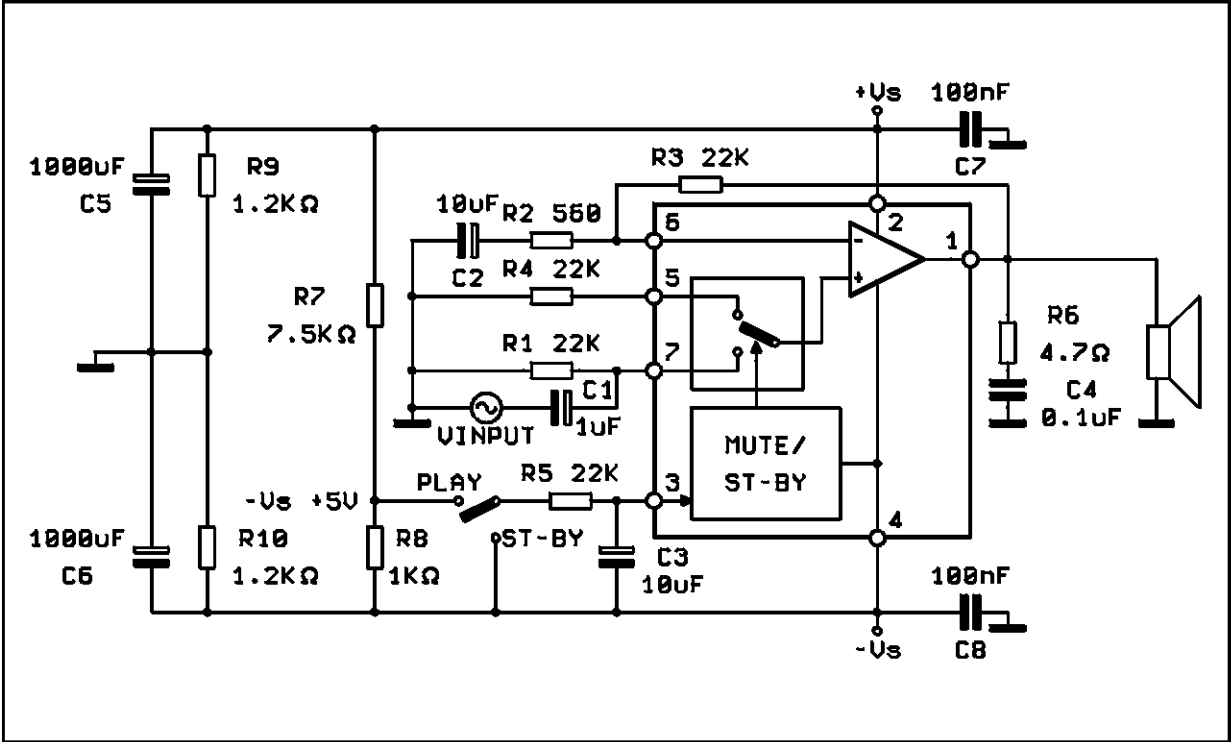

Figure 14: Demo Board Schematic.



MUTE/STAND-BY FUNCTION

The pin 3 (MUTE/STAND-BY) controls the amplifier status by three different thresholds, referred to $-V_s$.

When its voltage is lower than the first threshold (1V, with a $\pm 70\text{mV}$ hysteresis), the amplifier is in STAND-BY and all the final stage current gener-

ators are off. Only the input MUTE stage is on in order to prevent pop-on problems.

At $V_{\text{pin3}}=1.8\text{V}$ the final stage current generators are switched on and the amplifier operates in MUTE.

For $V_{\text{pin3}}=2.7\text{V}$ the amplifier is definitely on (PLAY condition)

Figure 15.

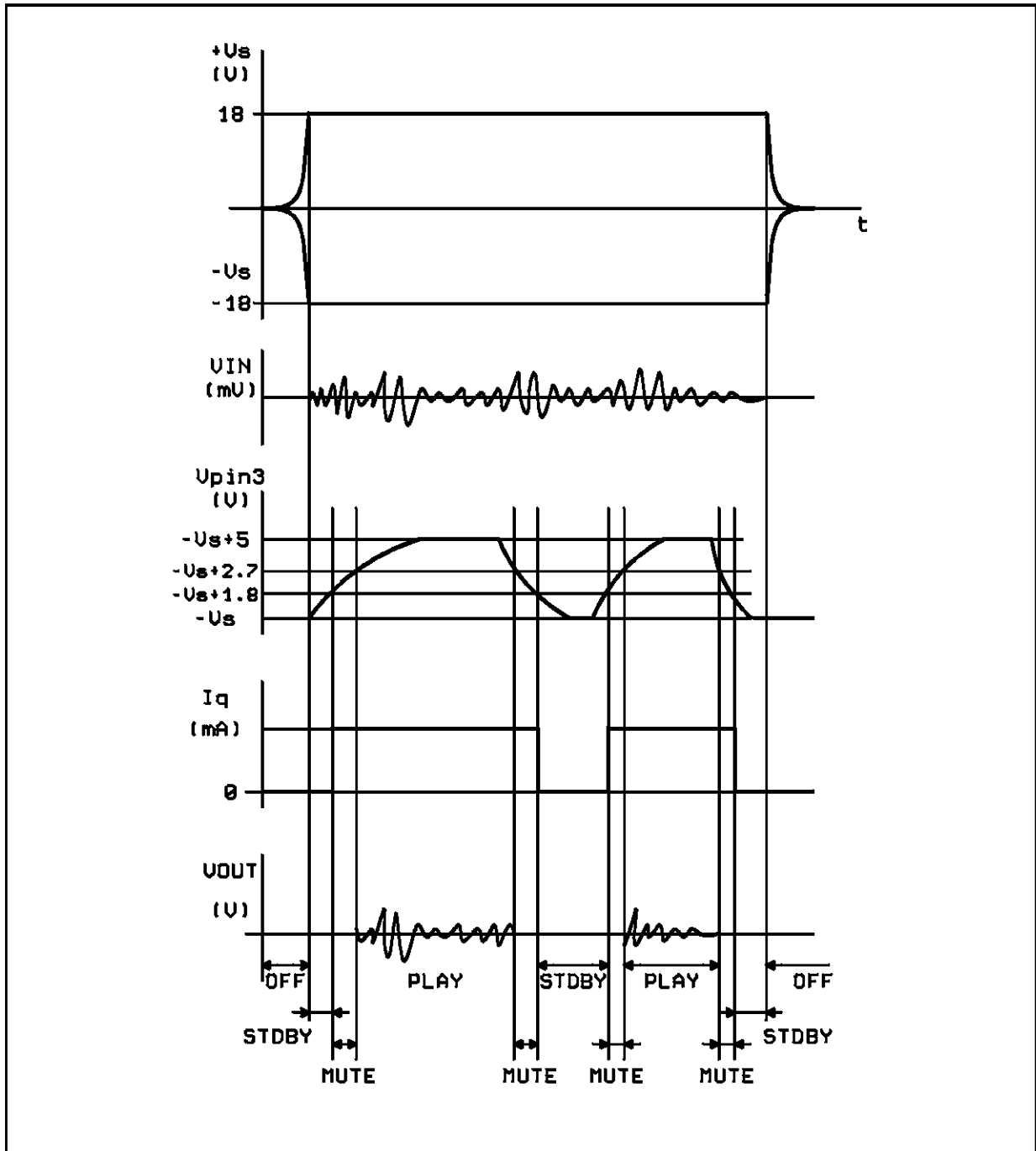

SHORT-CIRCUIT PROTECTION

The TDA7298 has an original circuit which protects the device during accidental short-circuit between output and GND / -Vs / +Vs, taking it in STAND-BY mode, so limiting also dangerous DC current flowing through the loudspeaker.

If a short-circuit or an overload dangerous for the final transistors are detected, the concerned SOA circuit sends out a signal to the latching circuit (with a 10µs delay time that prevents fast random spikes from inadvertently shutting the amplifier off) which makes Q₁ and Q₂ saturate (see Block Diagram). Q₁ immediately short-circuits to ground the A point turning the final stage off while Q₂ short-circuits to ground the external capacitor driving the pin 3 (Mute/Stand-by) towards zero potential.

Only when the pin 3 voltage becomes lower than 1V, the latching circuit is allowed to reset itself and restart the amplifier, provided that the short-circuit condition has been removed. In fact, a window comparator is present at the output and it is aimed at preventing the amplifier from restarting if the output voltage is lower than 0.35 Total Supply Voltage or higher than 0.65 Total Supply Voltage. If the output voltage lies between these two thresholds, one may reasonably suppose the short-circuit has been removed and the amplifier may start operating again.

The PLAY/MUTE/STAND-BY function pin (pin 3) is both ground- and positive supply-compatible and can be interfaced by means of the R₅, C₃ net either to a TTL or CMOS output (µ-Processor) or to a specific application circuit.

The R₅, C₃ net is fundamental, because connecting this pin directly to a low output impedance driver such as TTL gate would prevent the correct operation during a short-circuit. Actually a final stage overload turns on the protection latching circuit that makes Q₂ try to drive the pin 3 voltage under 0.8 V. Since the maximum current this pin can stand is 3 mA, one must make sure the following condition is met:

$$R_5 \geq \frac{(V_A - 0.7V)}{3mA}$$

that yields: R_{5, min} = 1.5 KΩ with V_A=5V.

In order to prevent pop-on and -off transients, it is advisable to calculate the C₃, R₅ net in such a way that the STAND-BY/MUTE and MUTE/PLAY threshold crossing slope (positive at the turn-on and vice-versa) is less than 100 V/sec.

THERMAL PROTECTION

The thermal protection operates on the 125µA current generator, linearly decreasing its value from 90°C on. By doing this, the A voltage slowly decreases thus switching the amplifier first to MUTE (at 145°C) and then to STAND-BY (155°C).

Figure 16: Thermal Protection Block Diagram

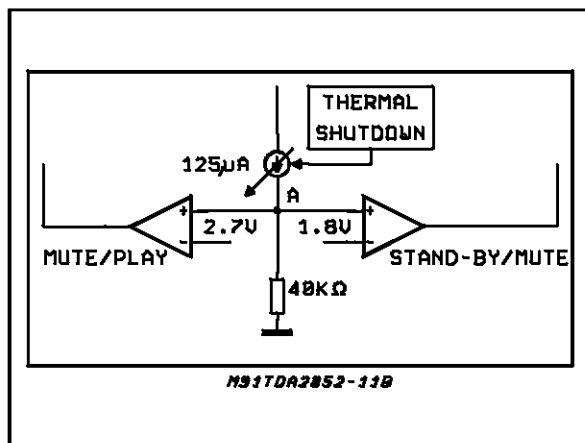

The maximum allowable power dissipation depends on the size of the external heatsink (thermal resistance case-ambient); figure 17 shows the dissipable power as a function of ambient temperature for different thermal resistance.

Figure 17: Maximum Allowable Power Dissipation vs. Ambient Temperature.

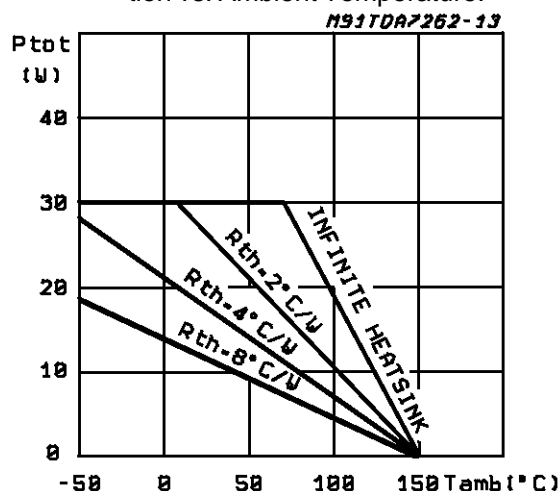

HEPTAWATT PACKAGE MECHANICAL DATA

DIM.	mm			inch		
	MIN.	TYP.	MAX.	MIN.	TYP.	MAX.
A			4.8			0.189
C			1.37			0.054
D	2.4		2.8	0.094		0.110
D1	1.2		1.35	0.047		0.053
E	0.35		0.55	0.014		0.022
F	0.6		0.8	0.024		0.031
F1			0.9			0.035
G	2.41	2.54	2.67	0.095	0.100	0.105
G1	4.91	5.08	5.21	0.193	0.200	0.205
G2	7.49	7.62	7.8	0.295	0.300	0.307
H2			10.4			0.409
H3	10.05		10.4	0.396		0.409
L		16.97			0.668	
L1		14.92			0.587	
L2		21.54			0.848	
L3		22.62			0.891	
L5	2.6		3	0.102		0.118
L6	15.1		15.8	0.594		0.622
L7	6		6.6	0.236		0.260
M		2.8			0.110	
M1		5.08			0.200	
Dia	3.65		3.85	0.144		0.152

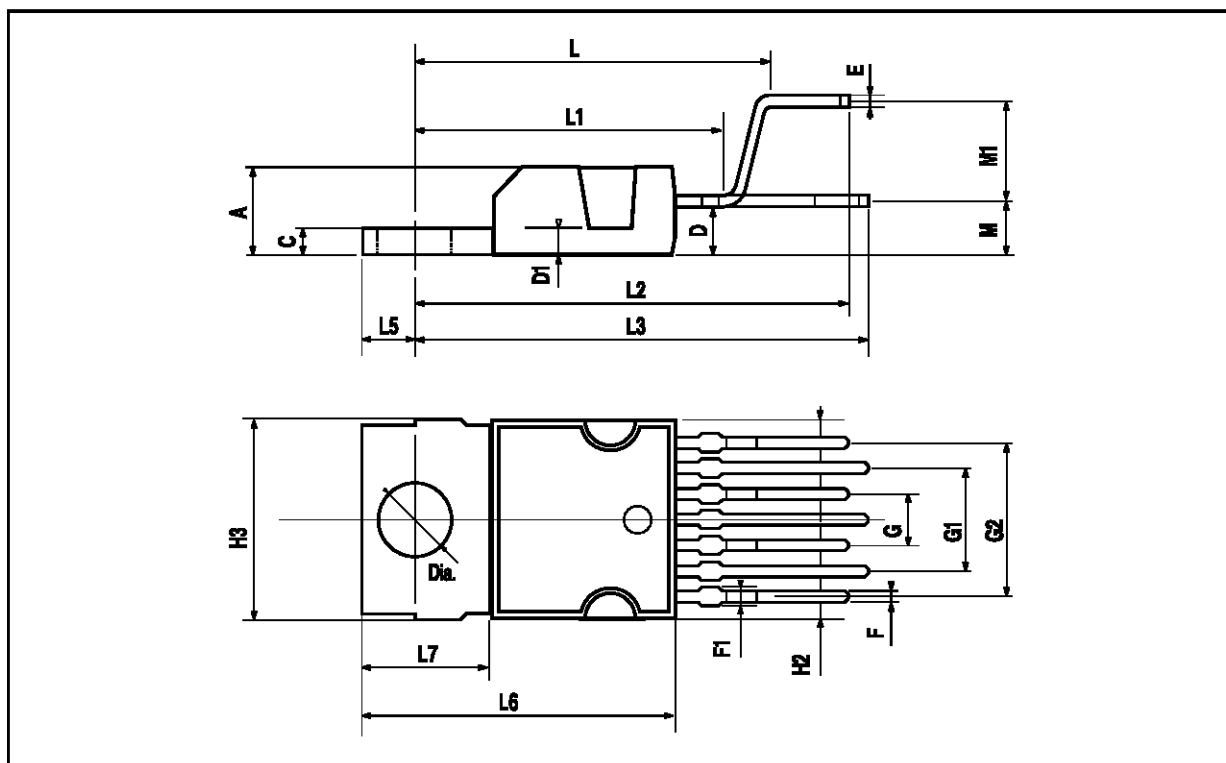

Information furnished is believed to be accurate and reliable. However, SGS-THOMSON Microelectronics assumes no responsibility for the consequences of use of such information nor for any infringement of patents or other rights of third parties which may result from its use. No license is granted by implication or otherwise under any patent or patent rights of SGS-THOMSON Microelectronics. Specifications mentioned in this publication are subject to change without notice. This publication supersedes and replaces all information previously supplied. SGS-THOMSON Microelectronics products are not authorized for use as critical components in life support devices or systems without express written approval of SGS-THOMSON Microelectronics.

© 1997 SGS-THOMSON Microelectronics - All Rights Reserved

HEPTAWATT™ is a Trademark of companies belonging to the SGS-THOMSON Microelectronics Group

SGS-THOMSON Microelectronics GROUP OF COMPANIES

Australia - Brazil - Canada - China - France - Germany - Hong Kong - Italy - Japan - Korea - Malaysia - Malta - Morocco - The Netherlands - Singapore - Spain - Sweden - Switzerland - Taiwan - Thailand - United Kingdom - U.S.A.