

N-CHANNEL SILICON POWER MOSFET

FAP-IIA SERIES

■ Features

- High speed switching
- Low on-resistance
- No secondary breakdown
- Low driving power
- High voltage
- $V_{GS}=\pm 30V$ Guarantee
- Avalanche-proof

■ Applications

- Switching regulators
- UPS
- DC-DC converters
- General purpose power amplifier

■ Maximum ratings and characteristics

● Absolute maximum ratings ($T_c=25^\circ C$ unless otherwise specified)

Item	Symbol	Rating	Unit
Drain-source voltage	V_{DS}	500	V
Continuous drain current	I_D	18	A
Pulsed drain current	$I_{D(puls)}$	72	A
Continuous reverse drain current	I_{DR}	18	A
Gate-source peak voltage	V_{GS}	± 30	V
Max. power dissipation	P_D	100	W
Operating and storage temperature range	T_{ch}	+150	$^\circ C$
	T_{stg}	-55 to +150	$^\circ C$

● Electrical characteristics ($T_c = 25^\circ C$ unless otherwise specified)

Item	Symbol	Test Conditions	Min.	Typ.	Max.	Units
Drain-source breakdown voltage	$V_{(BR)DSS}$	$I_D=1mA$ $V_{GS}=0V$	500			V
Gate threshold voltage	$V_{GS(th)}$	$I_D=1mA$ $V_{DS}=V_{GS}$	2.5	3.0	3.5	V
Zero gate voltage drain current	I_{DSS}	$V_{DS}=500V$ $V_{GS}=0V$	$T_{ch}=25^\circ C$	10	500	μA
			$T_{ch}=125^\circ C$	0.2	1.0	mA
Gate-source leakage current	I_{GSS}	$V_{GS}=\pm 30V$ $V_{DS}=0V$		10	100	nA
Drain-source on-state resistance	$R_{DS(on)}$	$I_D=9A$ $V_{GS}=10V$		0.25	0.35	Ω
Forward transconductance	g_{fs}	$I_D=9A$ $V_{DS}=25V$	9.0	18.0		S
Input capacitance	C_{iss}	$V_{DS}=25V$		3300	4950	pF
Output capacitance	C_{oss}	$V_{GS}=0V$		340	510	
Reverse transfer capacitance	C_{rss}	$f=1MHz$		80	120	
Turn-on time t_{on} ($t_{on}=t_{d(on)}+t_r$)	$t_{d(on)}$	$V_{CC}=300V$ $R_G=10\Omega$		35	55	ns
	t_r	$I_D=18A$		80	120	
Turn-off time t_{off} ($t_{off}=t_{d(off)}+t_f$)	$t_{d(off)}$	$V_{GS}=10V$		190	285	ns
	t_f			120	180	
Avalanche capability	I_{AV}	$L=100\mu H$ $T_{ch}=25^\circ C$	18			A
Diode forward on-voltage	V_{SD}	$I_F=2 \times I_{DR}$ $V_{GS}=0V$ $T_{ch}=25^\circ C$		1.0	1.5	V
Reverse recovery time	t_{rr}	$I_F=I_{DR}$ $V_{GS}=0V$ $-di/dt=100A/\mu s$ $T_{ch}=25^\circ C$		500		ns

● Thermal characteristics

Item	Symbol	Test Conditions	Min.	Typ.	Max.	Units
Thermal resistance	$R_{th(ch-a)}$	channel to ambient			30.0	$^\circ C/W$
	$R_{th(ch-c)}$	channel to case			1.25	$^\circ C/W$

■ Outline Drawings

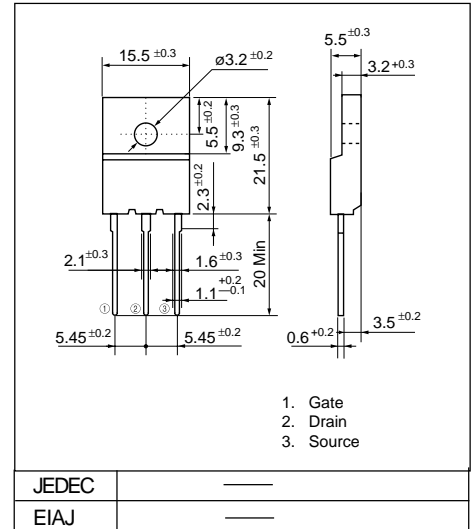

■ Equivalent circuit schematic

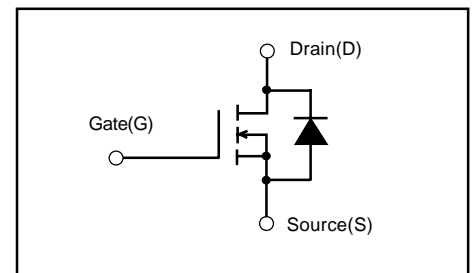

Characteristics

Typical output characteristics

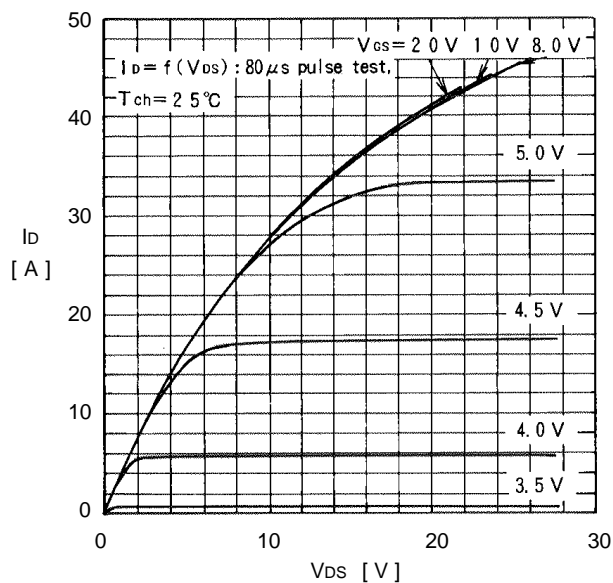

On state resistance vs. T_{ch}

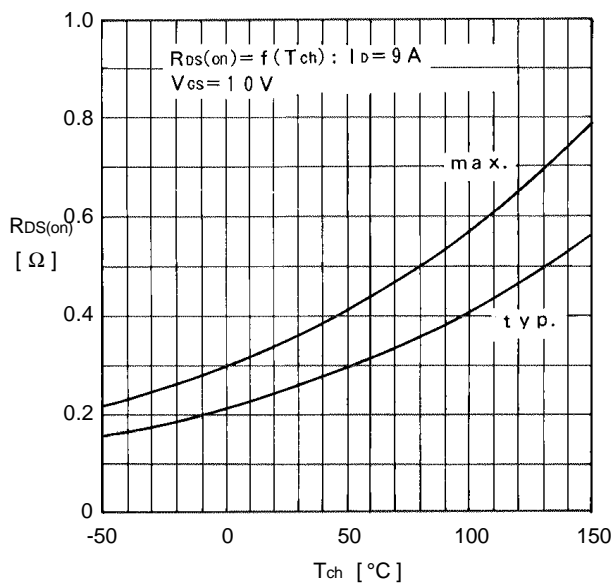

Typical transfer characteristics

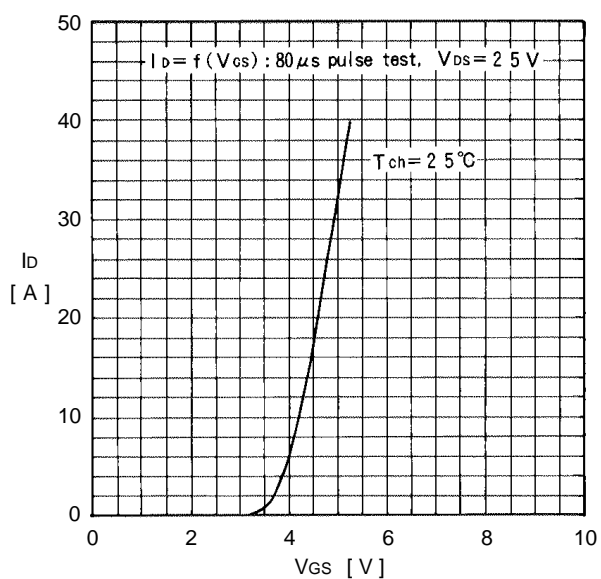

Typical Drain-Source on state resistance vs. I_D

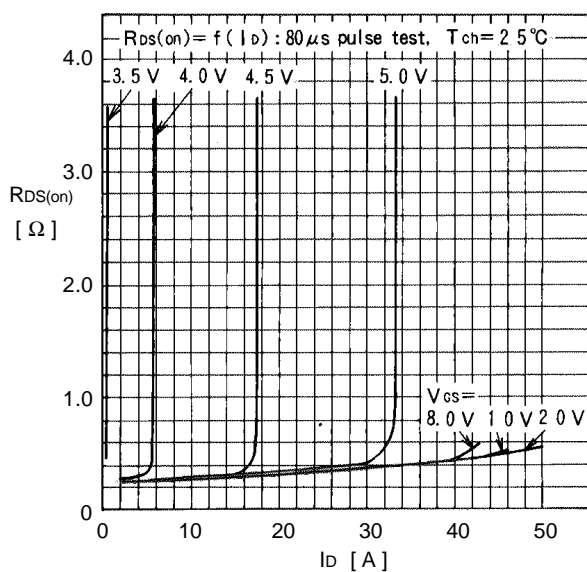

Typical forward transconductance vs. I_D

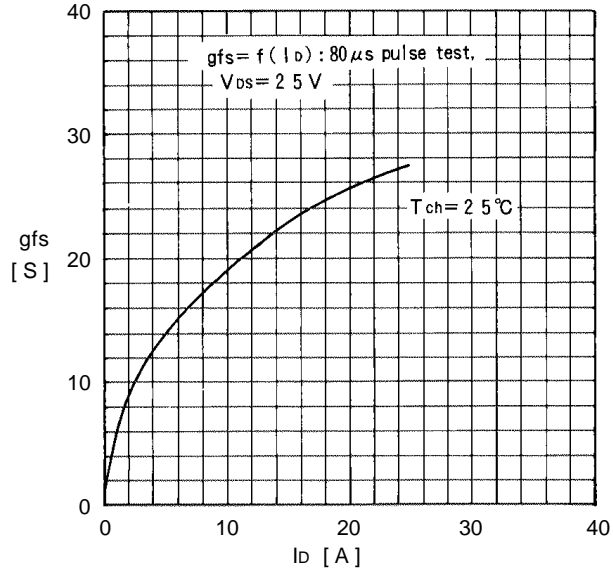

Gate threshold voltage vs. T_{ch}

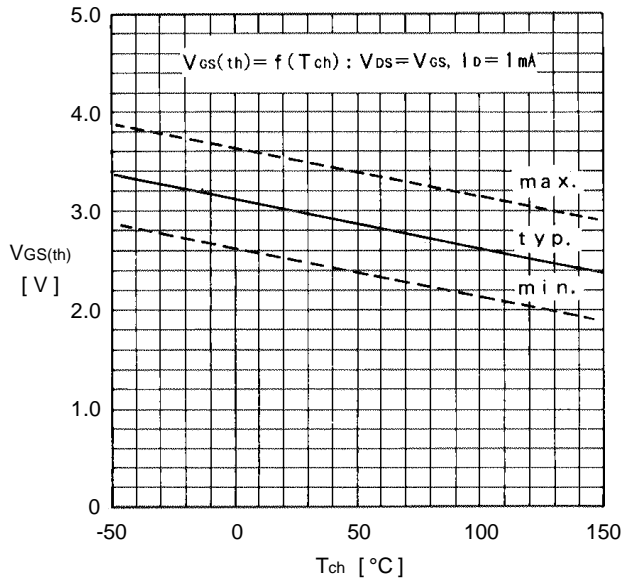

Typical capacitance vs. V_{DS}

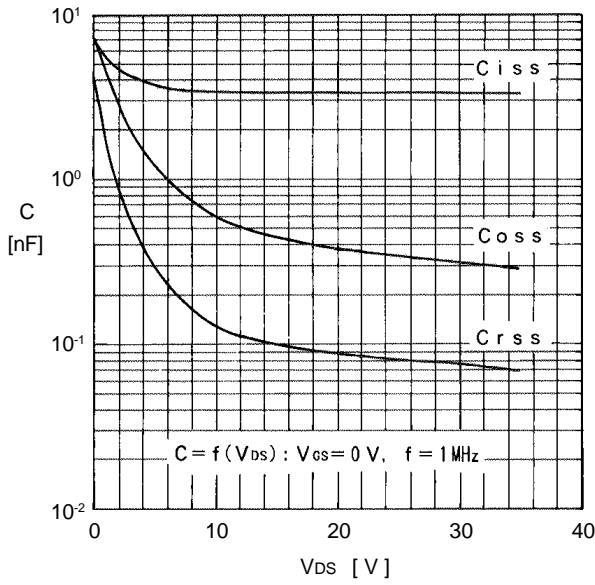

Typical input charge

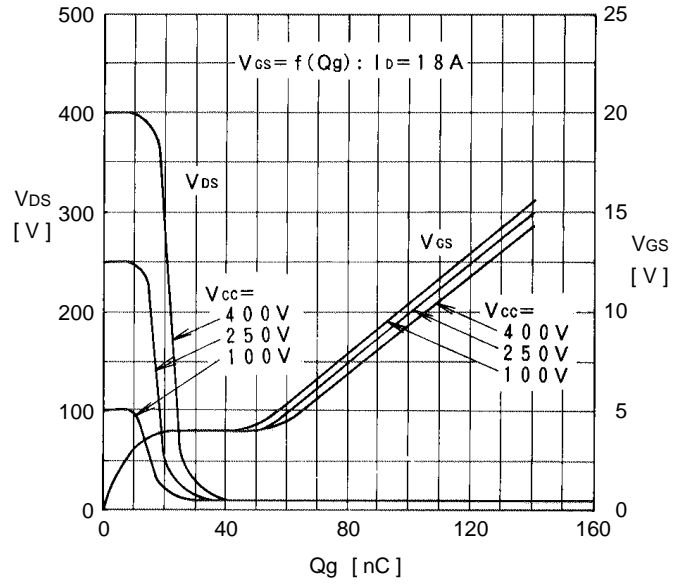

Forward characteristics of reverse diode

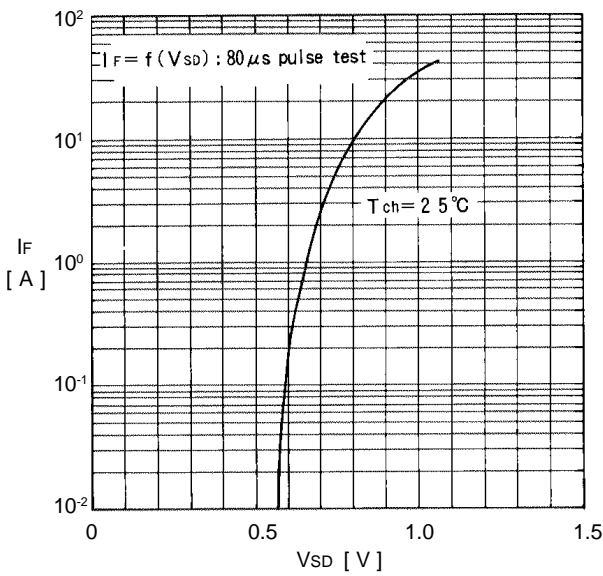

Allowable power dissipation vs. T_c

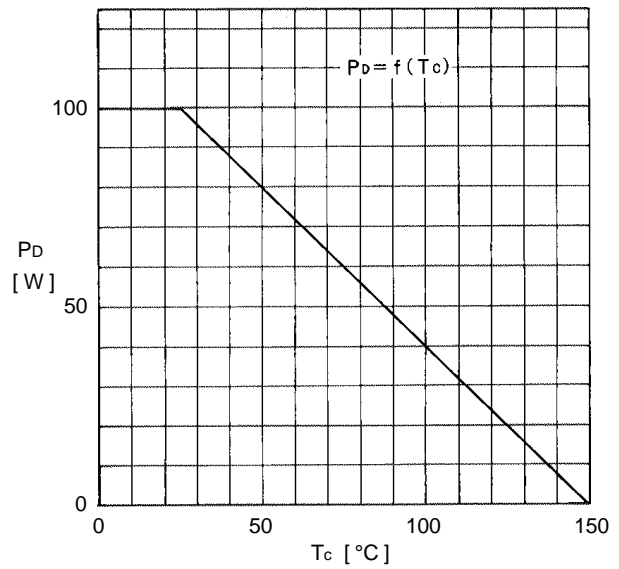

Safe operating area

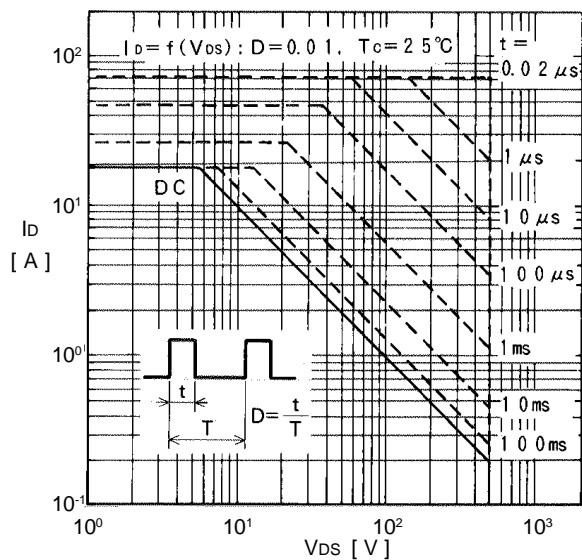

Transient thermal impedance

